



# 2024 FULL LINE CATALOG

Serving Multiple Markets with First-Class Dispensers Since 1907.



# CATALOG CONTENTS

<b>4</b>	<b>Palmer Fixture History</b>	<b>18</b>	<b>Standard Tissue Dispensers</b>
<b>6</b>	<b>Catalog Key / LEED</b>	<b>20</b>	<b>Bulk Soap Dispensers</b>
<b>7</b>	<b>ADA Compliant Products</b>	<b>22</b>	<b>Air Care</b>
<b>8</b>	<b>Touchless Roll Towel Dispensers</b>	<b>24</b>	<b>EcoTap Series</b>
<b>10</b>	<b>Roll Towel Dispensers</b>	<b>26</b>	<b>High Speed Hand Dryers</b>
<b>12</b>	<b>Folded Towel Dispensers</b>	<b>38</b>	<b>Safety &amp; Maintenance</b>
<b>14</b>	<b>Pad Printing</b>	<b>30</b>	<b>Signs</b>
<b>15</b>	<b>Universal Advantage</b>	<b>32</b>	<b>Napkin Dispensers</b>
<b>16</b>	<b>Jumbo Tissue Dispensers</b>	<b>33</b>	<b>Display Stands</b>
		<b>34</b>	<b>Replacement Keys / Warranty Information</b>

# THE HISTORY — OF PALMER FIXTURE —

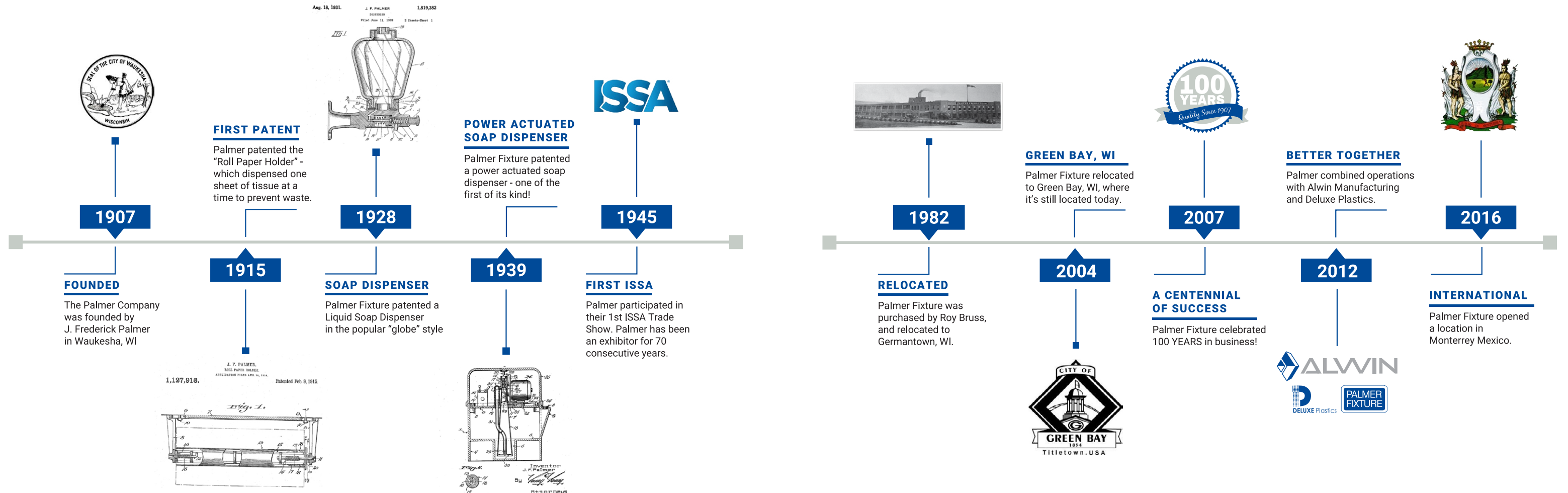

## ABOUT PALMER FIXTURE

At Palmer Fixture, we are devoted to providing you with a number of solutions based on your specific needs, along with our product offerings and expertise. As we continue to serve as a leader of the industry, we are continuously working on new products and ways to make your life cleaner, greener, and more hygienic.

Palmer Fixture, for over 100 years, has been committed to providing the most competitive value-added dispensing systems available. Palmer Fixture offers a variety of items from the traditional metal crank dispensers to our innovative automatic touchless dispensers and hand dryers. We are constantly expanding our product lines as we continue looking for more ways to satisfy our customers. Most of our products are made in the USA and are subject to strict quality control processes. Through extensive research and development, Palmer Fixture Company has maintained a world wide reputation for product excellence since 1907.

# PRODUCT CATALOG KEY

Watch for these icons throughout the catalog to indicate product details:



## Product Color Key:

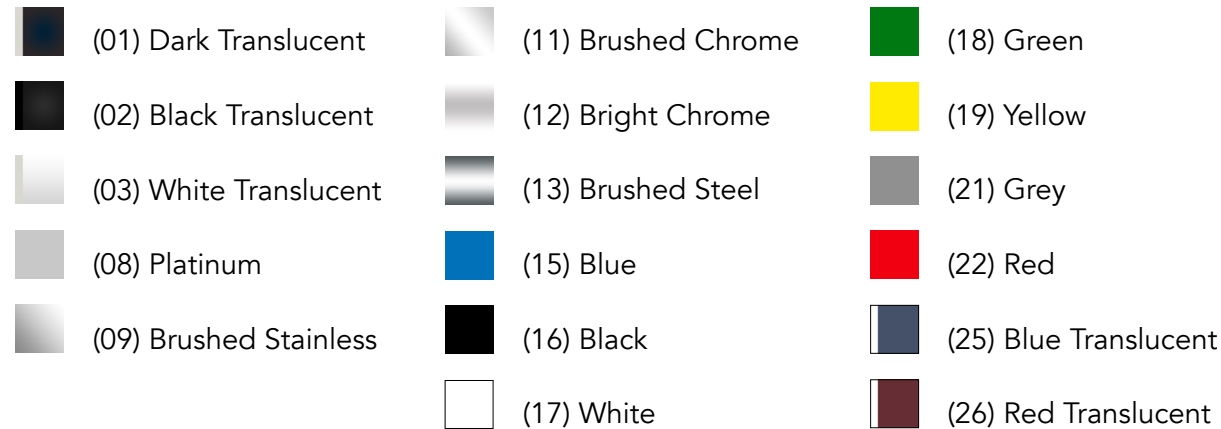

# LEED CREDIT INFORMATION

## What is LEED?

LEED, or Leadership in Energy & Environmental Design, is a green building certification program that recognizes best-in-class building strategies and practices. To receive LEED certification, building projects satisfy prerequisites and earn points to achieve different levels of certification. Prerequisites and credits differ for each rating system, and teams choose the best fit for their project.



## Which Palmer Fixture Products earn credits?

The BluStorm® High Speed Hand Dryer (pg. 12) earns LEED Credits for EAc1: Optimize Energy Performance and EAp2: Minimum Energy Performance

The EcoStorm® High Speed Hand Dryer (pg. 14) earns LEED Credits for EAc1: Optimize Energy Performance and EAp2: Minimum Energy Performance

For more information on the LEED Program and detailed requirements, visit [www.usgbc.org/leed](http://www.usgbc.org/leed)

# ADA COMPLIANT PRODUCTS

The Americans with Disabilities Act (ADA) defines the accessible requirements for the design and construction of washroom space in the United States. Detailed below are examples of the ADA installation requirements for hand dryers.

## As for the visually impaired, Rule 4.4.1 states:

Objects projecting from walls (for example, telephones) with their leading edges between 27 and 80 inches (685 mm and 2020 mm) above the finished floor shall protrude no more than 4 inches (100 mm) into walks, halls, corridors, passageways, or aisles. Objects mounted with their leading edges at or below 27 inches (685 mm) above the finished floor may protrude any amount.

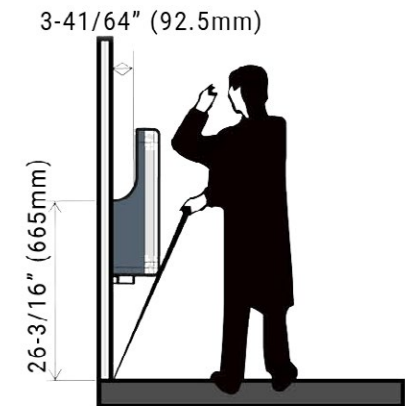

## According to ADA Regulation 4.2.5, concerning forward reach:

If the clear floor space only allows forward approach to an object, the maximum high forward reach allowed shall be 48 inches (1220 mm). The minimum for low forward reach is 15 inches (380 mm).

ADA Accessibility Guidelines (as measured from finished floor)	
Forward Reach Ranges - Unobstructed	
48" H max.	15" H min.

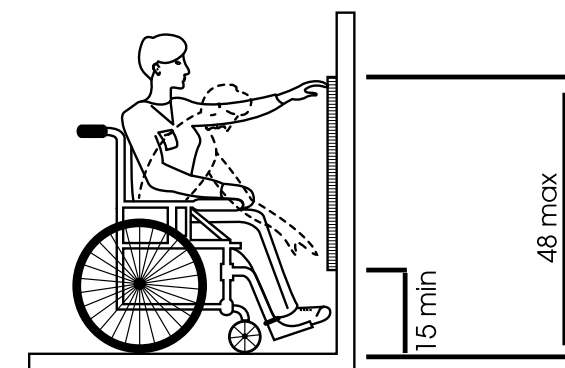

The above information is for informational purposes only and not intended to be an alternative to the ADA Accessibility Guidelines or specifications. For complete information on current ADA requirements, visit [www.ada.gov](http://www.ada.gov)



TOUCHLESS  
ROLL TOWEL  
DISPENSERS

The **TD0265 Electronic Touchless Roll Towel Dispenser** holds universal 8" towel rolls. Our patented paper saver mode reduces overall paper consumption. This unit is available with a translucent cover or with a faux-stainless in-mold finish. Full color, completely customizable in-mold labeling available with a 500 MOQ.



### Premium Electronic Hands Free Roll Towel Dispenser

model	TD0265
dimensions (in)	12.112"w x 16.598"h x 9.652"d
weight (lb)	5.80
key type	1
capacity	8"W x 8"D Roll Towel
batteries	4x "D" LR20 Alkaline

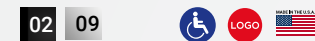

TOP  
SELLER

Touchless and Mechanical roll towel dispensers are universal for most 8" wide rolls. They are easy to load and install. The user only touches the paper required to dry their hands. These dispensers offer quick towel delivery without needing to touch the dispenser itself, making this a hygienic option for a variety of settings.



### Electronic Touchless Towel Dispenser

model	TD0235
dimensions (in)	11.39w x 13.21h x 8.58d
weight (lb)	4.00
key type	1
capacity	8"W x 8"D Roll Towel
batteries	4x "D" LR20 Alkaline

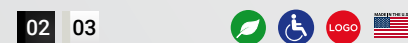

TOP  
SELLER

### Mechanical Auto-Cut Roll Towel Dispenser

model	TD0201
dimensions (in)	11.43w x 15.02h x 8.98d
weight (lb)	4.50
key type	1
capacity	8"W x 8"D Roll Towel

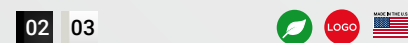

6"  
ROLL

### Electronic Hands-Free Roll Towel Dispenser

model	TD0234
dimensions (in)	11.52w x 11.42h x 7.69d
weight (lb)	3.65
key type	1
capacity	8"W x 6"D Roll Towel
batteries	4x "D" LR20 Alkaline

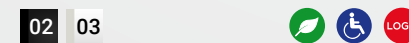

6"  
ROLL

### Mechanical Hands-Free Roll Towel Dispenser

model	TD0202
dimensions (in)	11.39w x 12.34h x 7.12d
weight (lb)	4.05
key type	1
capacity	8"W x 6"D Roll Towel

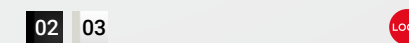

### Electronic Touchless Roll Towel Dispenser

model	TD0245
dimensions (in)	12.27w x 15.20h x 9.47d
weight (lb)	4.60
key type	1
capacity	8"W x 8"D Roll Towel
batteries	4x "D" LR20 Alkaline

### Electronic Touchless Roll Towel Dispenser w/ AC

model	TD0246*
weight (lb)	5.00

\* Includes AC Adaptor - no batteries

\* Only available in 01 or 02 color

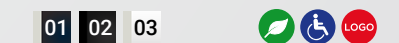



Palmer Fixture universal roll paper towel dispensers offer a smooth and quick delivery and provide an excellent value in roll towel dispensing. Not only can these dispensers be used in a variety of settings, they are easy to use and maintain. All of our Roll Towel Dispensers are Made in the U.S.A.!



**Auto-Transfer Push Bar Roll Towel Dispenser (Metal Back)**

model	TD0215
dimensions (in)	10.56w x 15.67h x 8.64d
weight (lb)	6.00
key type	1
capacity	8"W x 8"D Roll Towel

02 03   



**Auto-Transfer Push Bar Roll Towel Dispenser (Plastic Back)**

model	TD0216
dimensions (in)	10.74w x 15.49h x 8.96d
weight (lb)	4.75
key type	1
capacity	8"W x 8"D Roll Towel

02 03   



**Compact Lever Roll Towel Dispenser**

model	TD0220
dimensions (in)	11.88w x 13.71h x 9.16d
weight (lb)	3.75
key type	1
capacity	8"W x 8"D Roll Towel

02 03    



**Self-Adjusting Centerpull Roll Towel Dispenser**

model	TD0255
dimensions (in)	10.13w x 12.45h x 10.13d
weight (lb)	2.45
key type	1
capacity	9"W x 9"D Centerpull Towel

02  

Enhance your image by showing awareness for your patrons' hygiene and safety, with the **Mini-Fold Towel Dispenser** from Palmer Fixture. Reduce cost and conserve paper with a controlled delivery of one sheet at a time. Starter kits available include 2 Dispensers and 6 Packs of Paper.



### Mini-Fold Towel Dispenser

model	TD0177
dimensions (in)	4.00w x 11.125h x 5.625d
weight (lb)	0.95
key type	1
capacity	500 Mini-Fold Towels

### Starter Packs & Paper Refills

model	TD0178
paper	RP8096-17

Starter Pack includes 2 Towel Dispensers & 6 Packs of Paper

02



Palmer Fixture offers a variety of folded towel options that are available to use with our dispensers – Multifold, C-fold or Single Fold. All dispensers are ADA compliant when installed to the correct specifications. Folded towel dispensers are great options for medical facilities and restaurant kitchens.



### Premium Multi/C-Fold Towel Dispenser

model	TD0189
dimensions (in)	12.072" w x 16.897" h x 4.606" d
weight (lb)	-
key type	1
capacity	500 Multi-Fold Towels or 400 C-Fold Towels

02 09



### Plastic Multifold Towel Dispenser

model	TD0179
dimensions (in)	11.00w x 16.07h x 4.50d
weight (lb)	2.00
key type	1
capacity	540 Multifold Towels

02 03



### Mini Multifold Towel Dispenser

model	TD0171
dimensions (in)	11.00w x 10.80h x 4.50d
weight (lb)	1.40
key type	1
capacity	400 Multifold Towels

02 03



### Multifold/C-Fold Towel Dispenser

model	TD0175
dimensions (in)	11.375w x 15.22h x 5.00d
weight (lb)	3.50
key type	1
capacity	540 Multifold Towels OR 350 C-Fold Towels

01 03



### Multi-Fold/C-Fold Towel Dispenser

model	TD0170
dimensions (in)	11.125" w x 15.25" h x 4" d
weight (lb)	4.45
key type	1
capacity	540 Multifold Towels OR 350 C-Fold Towels

09



### Metal Single Fold Towel Dispenser

model	TD0091
dimensions (in)	11.74w x 9.23h x 5.59d
weight (lb)	4.40
key type	1
capacity	450 Single Fold Towels

17



## ADD A SPLASH OF COLOR!



### PAD PRINTING

Palmer Fixture offers several customizable dispensers. Your logo will surely stand out when printed in our **standard metallic silver ink\***. Logos are printed on the bottom center of the dispenser cover.

The logo can be up to 2.5 inches wide, with a height of up to 1.5 inches. Our Made in the U.S.A. dispensers provide a consistent, first-class quality offering to you and your customers.

Add your logo today for a one of a kind look!

Look for the  throughout this catalog to indicate which dispensers are available for customization.



### How to Get YOUR Logo on Palmer Dispensers

Contact us via email at [info@palmerfixture.com](mailto:info@palmerfixture.com) or by calling **1-800-558-8678** for a quote.

\*colors other than standard silver may incur additional charges

# UNIVERSAL ADVANTAGE

A QUICK GUIDE TO CHOOSING UNIVERSAL DISPENSERS

### CHOOSE YOUR PAPER

**Universal Dispensers** provide maximum flexibility when purchasing **Universal Roll Towels**. Purchase where you want, whenever you need it.

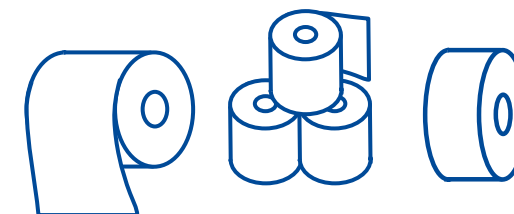

### AVOID COSTLY CONTRACTS

Choosing **Universal Dispensers** avoids long term contracts, and may save you between 25-50% when purchasing **Universal Roll Towels**.

### BE YOUR OWN BRAND

Brand your new **Universal Dispensers** with the Palmer Fixture Pad Printing option! Not only is Pad Printing easy and affordable, it's also a great way to advertise your company.



## OVER 30 DISPENSER MODELS TO CHOOSE FROM





NEW

### Premium Single 9" Jumbo Tissue Dispenser

model	RD0056
dimensions (in)	11.708"w x 11.727"h x 4.08"d
weight (lb)	2.00
key type	1
capacity	9" Jumbo Tissue

### Premium Twin 9" Jumbo Tissue Dispenser

model	RD0057
dimensions (in)	21.208"w x 11.749"h x 4.08"d
weight (lb)	3.40
key type	1
capacity	Two 9" Jumbo Tissue

02 09



TOP  
SELLER

### Twin 9" Jumbo Tissue Dispenser

model	RD0027*
dimensions (in)	20.23w x 11.71h x 5.37d
weight (lb)	2.85
key type	1
capacity	Two 9" Jumbo Tissue

\*Add 'F' to add a 2-1/4" - 3-3/8" Core Adaptor

02 03



### Single 9" Jumbo Tissue Dispenser

model	RD0026
dimensions (in)	11.47w x 11.22h x 5.37d
weight (lb)	1.65
key type	1
capacity	9" Jumbo Tissue

\*Add 'F' to add a 2-1/4" - 3-3/8" Core Adaptor

02 03



NEW

### Single 9" Jumbo Tissue Dispenser

model	RD0016
dimensions (in)	10.31w x 11.81h x 4.50d
weight (lb)	1.60
key type	1
capacity	9" Jumbo Tissue

02 03 17



### Single 13" Jumbo Tissue Dispenser

model	RD0330
dimensions (in)	16.50w x 14.30h x 4.89d
weight (lb)	2.35
key type	1
capacity	13" Jumbo Tissue

02



### Single 12" Senior Jumbo Tissue Dispenser

model	RD0059
dimensions (in)	15w x 15.20h x 5.50d
weight (lb)	2.60
key type	1
capacity	12" Jumbo Tissue

02



STUB  
ROLL

### Single 9" Jumbo Tissue Dispenser w/ Stub Roll

model	RD0024
dimensions (in)	16.21w x 12.05h x 5.36d
weight (lb)	2.60
key type	1
capacity	9" Jumbo Tissue + Stub

02 03



### Twin 9" Jumbo Tissue Dispenser

model	RD0327
dimensions (in)	19.69w x 11.18h x 5.12d
weight (lb)	5.15
key type	1
capacity	Two 9" Jumbo Tissue

09



### Single 10" Senior Jumbo Tissue Dispenser

model	RD0346
dimensions (in)	10.63w x 10.63h x 4.65d
weight (lb)	2.80
key type	13
capacity	10" Jumbo Tissue

09



### Single 14" Jumbo Tissue Dispenser

model	RD0348
dimensions (in)	14.09w x 14.25h x 4.65d
weight (lb)	4.05
key type	13
capacity	14" Jumbo Tissue

09



**Two-Roll Standard Tissue Dispenser**

model	RD0025
dimensions (in)	6.02w x 13.13h x 6d
weight (lb)	2.10
key type	1
capacity	Two Standard Tissue Rolls



**Two-Roll Standard Tissue Dispenser**

model	RD0028
dimensions (in)	6.02w x 13.04h x 6.16d
weight (lb)	1.75
key type	1
capacity	Two Standard Tissue Rolls



**7.5\" Mini Twin Standard Core Tissue Dispenser**

model	RD0323
dimensions (in)	16.611w x 9.806h x 5.477d
weight (lb)	2.50
key type	1
capacity	Two 7.5\" Standard Core Tissue

\*Add 'G' to any model for the Micro Core option

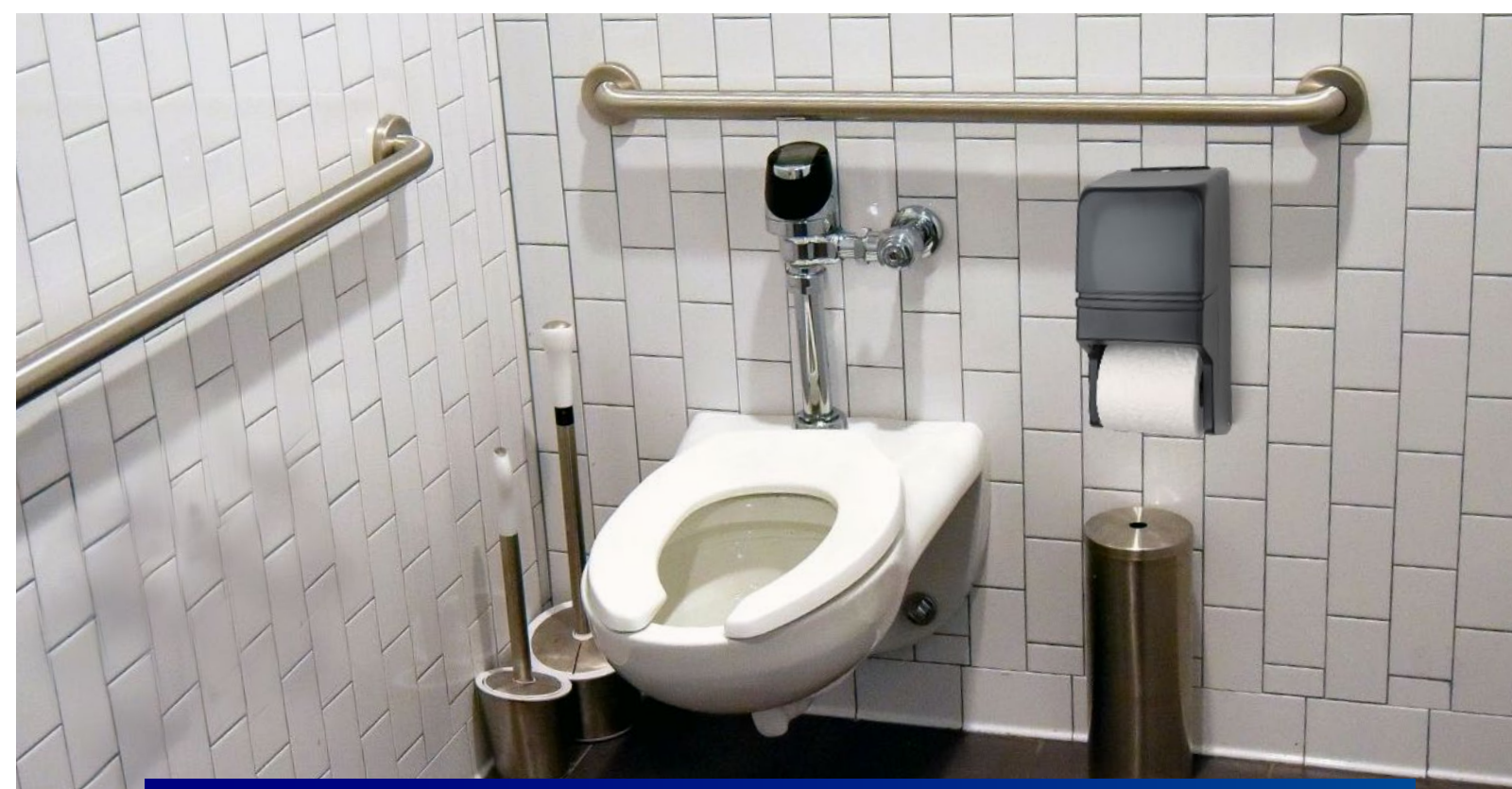

All Palmer Fixture standard tissue dispensers use standard "D" rolls with a 1-1/2" core. These toilet paper dispensers are ideal for small business restrooms or single stall restroom settings. Standard Tissue Dispensers are ADA compliant when installed to the correct specifications.



**Mini Twin Standard Tissue Dispenser**

model	RD0321*
dimensions (in)	11.86w x 7.32h x 5.48d
weight (lb)	1.60
key type	1
capacity	Two Standard Tissue Rolls

\*Add 'G' to any model for the Micro Core option



**4-Roll Carousel \"Turnado\" Tissue Dispenser**

model	RD0044
dimensions (in)	13.11w x 14.93h x 6.08d
weight (lb)	3.55
key type	2
capacity	Four Standard Tissue Rolls



**Stainless Steel Two-Roll Standard Tissue Dispensers**

model	RD0325
dimensions (in)	5.83w x 13.125h x 5.83d
weight (lb)	3.30
key type	1
capacity	Two Standard Tissue Rolls



**Metal Single Roll Standard Tissue Dispenser**

model	RD0381
dimensions (in)	6.00w x 4.25h x 2.75d
weight (lb)	0.42
key type	NA
capacity	One Standard Tissue Roll

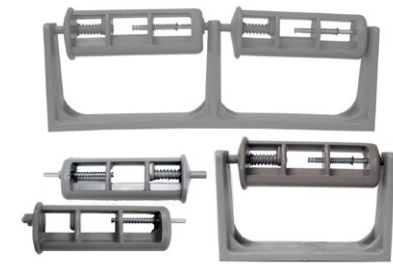

**Governor & No Waste Tissue Spindles**

model (single)	RD0401 or RD0404
dimensions (in)	6.50w x 4.50h x 1.75d
capacity	One Standard Tissue Roll
model (double)	RD0421 or RD0424
dimensions (in)	12.50w x 4.50h x 1.75d
capacity	Two Standard Tissue Rolls

\*Add 'P' to any model for the Free Turning option

model (spindle)	RS0201 or RS0402
dimensions (in)	6.500w x 4.50h x 1.75d





**Electronic Touchless Bulk Liquid Dispenser**

model	SE0900
dimensions (in)	5.00w x 10.50h x 4.75d
weight (lb)	1.80
key type	15
capacity	1000mL Bulk Liquid Soap
batteries	6x "AA" Alkaline

16 17



**Manual Bulk Liquid Soap Dispenser**

model	SD0927
dimensions (in)	4.33w x 7.68h x 4.33d
weight (lb)	.67
key type	NA
capacity	1000mL Bulk Liquid Soap

02



**Manual Bulk Liquid Soap Dispenser**

model	SD0942
dimensions (in)	5.25w x 9.875h x 4.50d
weight (lb)	1.54
key type	NA
capacity	1000mL Bulk Liquid Soap

16 17

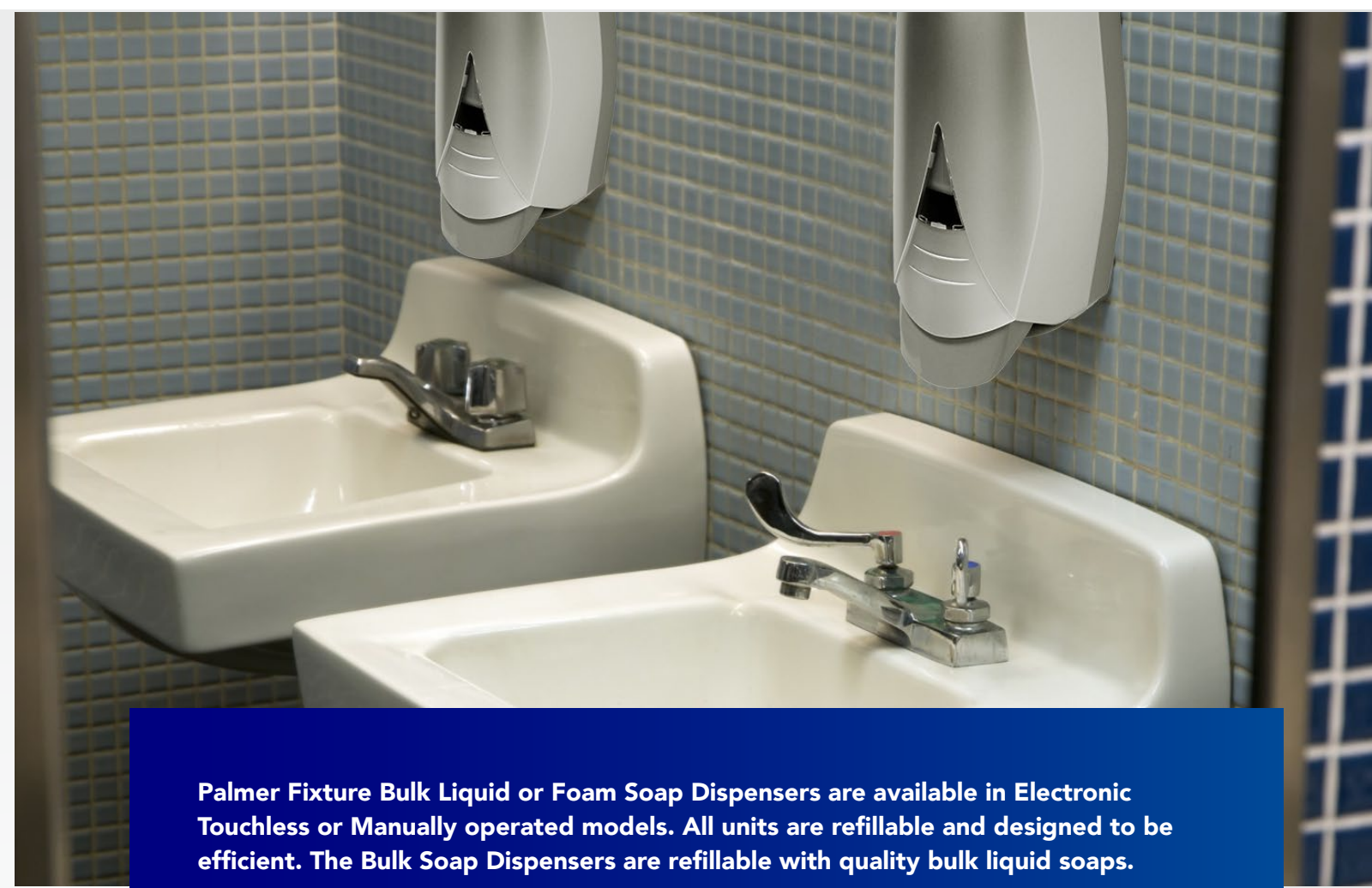

**Palmer Fixture Bulk Liquid or Foam Soap Dispensers are available in Electronic Touchless or Manually operated models. All units are refillable and designed to be efficient. The Bulk Soap Dispensers are refillable with quality bulk liquid soaps.**



**Electronic Touchless Bulk Foam Dispenser**

model	SF0900
dimensions (in)	5.00w x 10.50h x 4.75d
weight (lb)	1.80
key type	15
capacity	1000mL Bulk Foam Soap
batteries	6x "AA" Alkaline

16 17



**Electronic Bulk Foam Dispenser**

model	SF2150
dimensions (in)	5.75w x 10.43h x 4.33d
weight (lb)	1.95
key type	11
capacity	1000mL Bulk Foam Soap
batteries	4x "C" Alkaline

08 16 17



**Manual Bulk Foam Soap Dispenser**

model	SF0942
dimensions (in)	5.25w x 9.875h x 4.50d
weight (lb)	1.54
key type	NA
capacity	1000mL Bulk Foam Soap

16 17



**Manual Bulk Foam Dispenser**

model	SF2111
dimensions (in)	4.80w x 10.71h x 5.04d
weight (lb)	1.15
key type	10
capacity	1000mL Bulk Foam Soap

08 16 17



## Vapor-Air Mist Neutralizer

The Vapor-Air Mist Neutralizer is an exciting new alternative to all other deodorizing systems. Inside the Vapor Mist Dispenser, a ceramic disc vibrates as electricity passes through. This propels the ultra fine Vapor-Air Fragrance particles into the room. Dispensers can be placed in restrooms, hotels, offices and schools, improving indoor air quality. The air you breathe is better, making your surrounding environment much more pleasant.

model	color	weight (lb)	dimensions (in)
PA0401-17	white	1.00	3.375w x 7.375h x 2.50d
model	scent	weight (oz)	
PA0402	Mango Bay	4 oz	
PA0403	Mountain Air	4 oz	
PA0404*	Lavender Lace	4 oz	
PA0406*	Sunburst	4 oz	

**Demo Kits Available in all scents. Please call 1-800-558-8678.**  
\*indicates available by special order

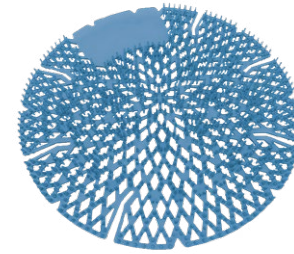

## Blossom Urinal Screen

model	scent
PA0101	Melon Mist
PA0102	Mountain Air
PA0103	Mango Bay
PA0104*	Blue Blossom
PA0105*	Neutra Scent
PA0106*	Ice
PA0107*	Calypso Lime
PA0108*	Sunburst
PA0109*	Lavender Lace
PA0110-00	Apple Cinnamon

dimensions(in) 7¼ø - ¾” thickness  
weight (lb) 1.7oz

\*indicates available by special order



## Splash Guard Urinal Screen

model	scent
PA0201	Neutra Scent
PA0202	Mountain Air
PA0203	Melon Mist
PA0204*	Calypso Lime
PA0205*	Sunburst
PA0206*	Apple Cinnamon
PA0207*	Mango Bay
PA0208*	Lavender Lace

dimensions(in) 7<sup>3</sup>/<sub>8</sub>ø - 7/16” thickness  
weight (lb) 3.2oz

\*indicates available by special order

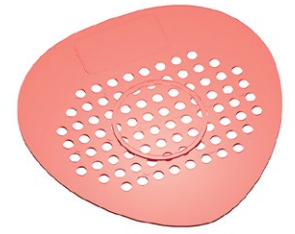

## Deodorant Vinyl Urinal Screen

model	scent
PA0501*	Cinnamon
PA0502	Natural
PA0503*	Apple
PA0504*	Natural
PA0505*	Lemon
PA0506	Cherry
PA0507	Evergreen

dimensions(in) 7.50h x 7.75w  
weight (lb) 3.2oz

\*indicates available by special order



## Passive Air Dispenser & Cartridges

The Passive Air Dispenser is specially designed to hold the Passive Air Refill Cartridges. It can be placed in bathroom stalls, restrooms, offices, hallways, kitchens, etc. The Passive Air Refill is the exciting passive deodorant cartridge for freshening the air in any size space. Forget about liquid spills or accidents, as the solid design of the cartridge eliminates the mess.

model	color	weight (lb)	dimensions (in)
PA0700-17	white	0.20	2.75w x 6.50h x 2.75d
model	scent	weight (oz)	
PA0701	Melon Mist	4.50 oz	
PA0702*	Calypso Lime	4.50 oz	
PA0703	Mountain Air	4.50 oz	
PA0704*	Sunburst	4.50 oz	
PA0705*	Apple Cinnamon	4.50 oz	
PA0706	Mango Bay	4.50 oz	
PA0707	Lavender Lace	4.50 oz	

\*indicates available by special order



## Non-Para Block Urinal Screen

model	scent
PA0601*	Evergreen
PA0602	Evergreen w/ Enzymes
PA0603*	Lavender Lace
PA0604*	Cherry
PA0605*	Apple
PA0606*	Cinnamon
PA0607*	Clean Breeze

dimensions(in) 6.5w x 1.5h x 6.5d  
weight (lb) 4.5oz

\*indicates available by special order



## Scented Bowl Clip

model	scent
PA0301	Mountain Air
PA0302	Mango Bay
PA0303	Melon Mist
PA0304*	Calypso Lime
PA0305*	Sunburst
PA0306*	Apple Cinnamon
PA0307*	Lavender Lace

dimensions(in) 4w x 2.4375h x 2.4375d  
weight (lb) 11oz

\*indicates available by special order

**PALMER-AIR™**  
AIR CARE SOLUTIONS

VAPOR MIST DISPENSERS, URINAL SCREENS, BOWL CLIPS & MORE NOW AVAILABLE!

Learn more at [www.palmerfixture.com](http://www.palmerfixture.com)

<b>URINAL SCREENS</b> <p>4 Styles Available 18 Different Scents!</p>	<b>BOWL CLIPS</b> <p>1 Classic Style 7 Different Scents!</p>	<b>AIR CARE</b> <p>2 Dispenser Options 7 Different Scents!</p>
-----------------------------------------------------------------------------	---------------------------------------------------------------------	-----------------------------------------------------------------------

DEMO KITS AVAILABLE • CALL 1-800-558-8678

# TOUCHFREE SOPHISTICATION

Introducing the EcoTap Trio  
FOAM SOAP | FAUCET | HAND DRYER

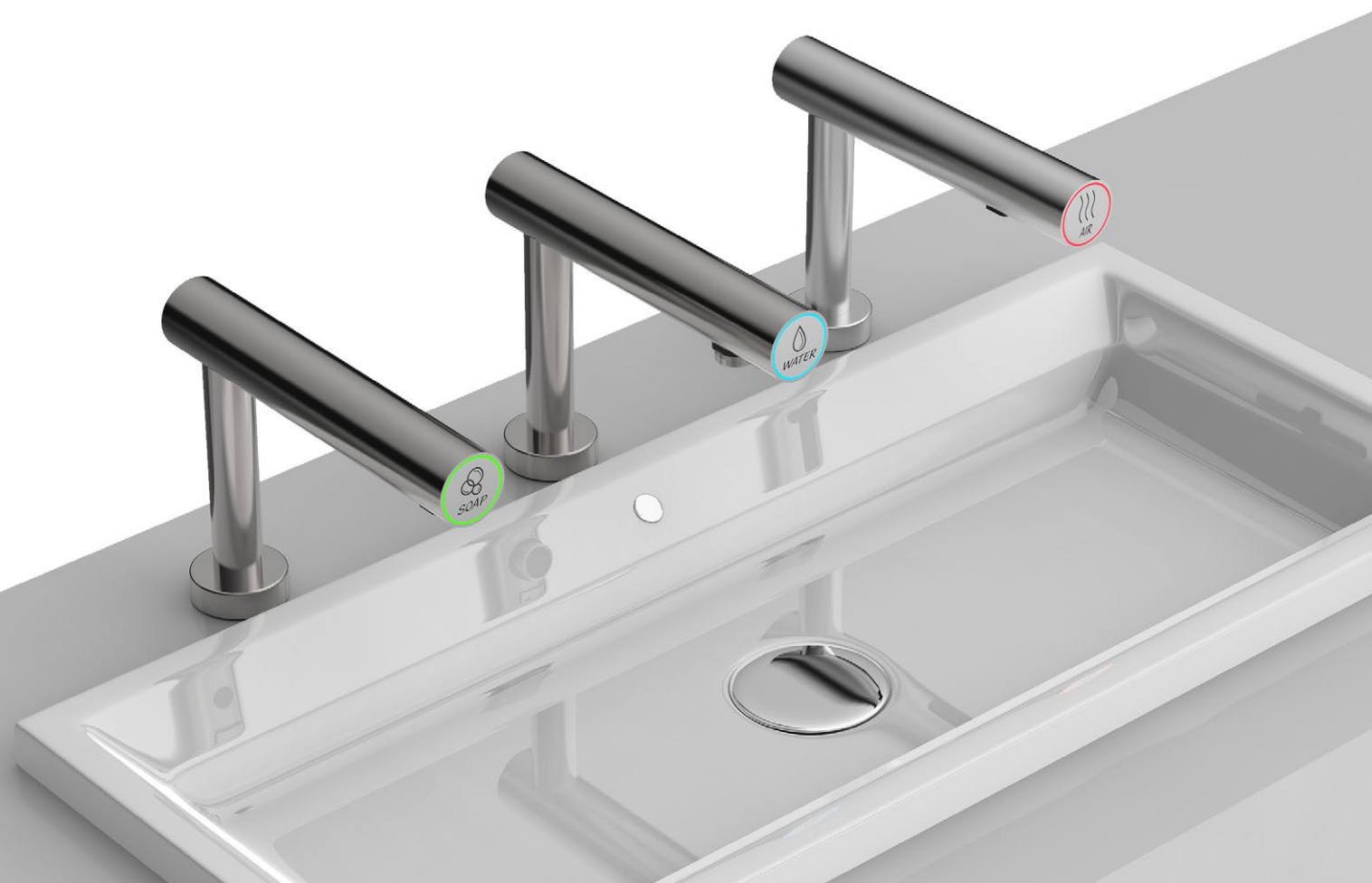

**WALL MOUNT OPTION  
ALSO AVAILABLE!**  
\*SPECIAL ORDER\*

## EcoTap Hand Dryer

<b>Material:</b> Stainless Steel	<b>Motor Type:</b> Adjustable brush type, dual ball bearings	
<b>Operating Airflow:</b> 16,535-19,882 LFM, Adjustable	<b>Sound Level:</b> MIN 68.5dB to 70.5dB MAX @1m	
<b>Thermal Protection:</b> Thermostat Shuts Off 203°F (95°C) Thermal Cut-Off at 185°F (85°C)	<b>Air Output Temperature:</b> 122°F (57°C) Ambient Temperature 77°F (25°C)	
<b>Isolation:</b> Class 1	<b>Drip Proof:</b> IP35	
<b>Watts:</b> 500W	<b>RPM:</b> 22,000-29,000, Adjustable	
<b>Model, Voltage &amp; Amps:</b>	<b>Mounting:</b> Surface Spout with Undermount Motor	
HD0935-09      110/120 Volts      7.6-8.4 Amps	<b>Dimensions:</b> 1.97" W x 6.69" H x 8.66" D (spout) 12.05" W x 7.60" H x 5.85" D (motor)	
HD0936-09 (special order)      220/240 Volts      3.8-4.2 Amps		
<b>Wall Mount (Special Order):</b> HD0935-09W		

## EcoTap Automatic Faucet

<b>Material:</b> Stainless Steel	<b>Power Source:</b> AC
<b>Sensing Range:</b> 4.72" ± .78", Adjustable	<b>Auto Shut-Off:</b> 1 Minute
<b>Operating Water Pressure:</b> 10~100 PSI	<b>Flowing Volume:</b> .05-1 L/Minute
<b>Drip Proof:</b> IP35	<b>Mounting:</b> Surface Spout
<b>Model:</b> AF0304-09	<b>Dimensions:</b> 1.97" W x 6.69" H x 8.66" D (spout)
<b>Wall Mount (Special Order):</b> AF0304-09W	

## EcoTap Foam Soap Dispenser

<b>Material:</b> Stainless Steel	<b>Power Source:</b> AC
<b>Sensing Range:</b> 4.72" ± .78", Adjustable	<b>Capacity:</b> 1500 mL Foam Soap
<b>Pump Life Cycle:</b> 100K	<b>Mechanism Life Cycle:</b> 500K
<b>Drip Proof:</b> IP35	<b>Mounting:</b> Surface Spout
<b>Model:</b> SD1500-09 (liquid available for special order)	<b>Dimensions:</b> 1.97" W x 6.69" H x 8.66" D (spout)
<b>Wall Mount (Special Order):</b> SD1500-09W	

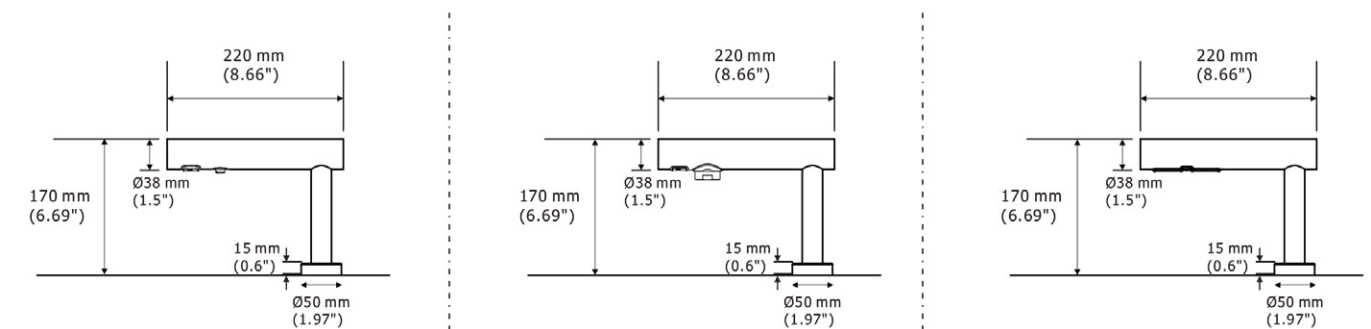

**Recommended Distance Between Units: 7.09" (180mm)**



### iStorm2 High Speed Hand Dryer

<b>Material:</b> Polycarbonate ABS (ION+)	<b>Motor Type:</b> 1HP, 350-700 Watts
<b>Operating Airflow:</b> 19,476 LFM, Adjustable	<b>Sound Level:</b> 65dB - 78dB MAX
<b>Thermal Protection:</b> Motor Shuts Off at 275°F (135°C) Heater Shuts Off at 288°F (142°C)	<b>Air Output Temperature:</b> 140°F (60°C) Ambient Temperature 68°F (20°C)
<b>Isolation:</b> Class 1	<b>Drip Proof:</b> IP23
<b>Watts:</b> 1600W (700W w/ heater off)	<b>RPM:</b> 11,000 - 20,000, Adjustable
<b>Model, Voltage &amp; Amps:</b>	<b>Mounting:</b> Surface
HD0983 110/120 Volts 12.2-13.3 Amps	<b>Dimensions:</b> 12.67" W x 24.59" H x 7.28" D
HD0984 208/220 Volts 5.7-6.6 Amps	<b>Weight:</b> 23.80lbs
HD0985 (special order) 277 Volts 6.6 Amps	<b>Colors:</b> 08 Platinum, 16 Black, 17 White



### BluStorm High Speed Hand Dryer - Surface or Recess Mount

<b>Material:</b> Stainless Steel	<b>Motor Type:</b> Adjustable brush type, dual ball bearings
<b>Operating Airflow:</b> 32.4-58.9 CFM, Adjustable	<b>Sound Level:</b> 68.2dB
<b>Thermal Protection:</b> Motor Shuts Off at 275°F (120V), 221°F (240V) Heater Shuts Off at 185°F (85°C)	<b>Air Output Temperature:</b> 131°F (55°C) Ambient Temperature 77°F (25°C)
<b>Isolation:</b> Class 1	<b>Drip Proof:</b> IP31
<b>Watts:</b> Heater Element 450-700W, Adjustable	<b>RPM:</b> 12,000-18,000, Adjustable
<b>Model, Voltage &amp; Amps:</b>	<b>Mounting:</b> Surface or Recessed
HD0950-09 110/120 Volts 12.5-13.4 Amps	<b>Dimensions:</b> 8.94" W x 11.125" H x 6.97" D   12.10lbs (surface) 9.84" W x 20.20" H x 7.06" D   20.70lbs (recessed)
HD0951-09 220/240 Volts 8-8.5 Amps	
HD0955-09 110/120 Volts 12.5-13.4 Amps	



### BluStorm Bolt High Speed Hand Dryer

<b>Material:</b> Stainless Steel	<b>Motor Type:</b> 11/16HP, Brush Type, Dual Ball Bearings
<b>Operating Airflow:</b> 21,243 LFM, Adjustable	<b>Sound Level:</b> 76.2 dB
<b>Thermal Protection:</b> Motor Shuts Off at 275°F (135°C) Heater Shuts Off at 185°F (85°C)	<b>Air Output Temperature:</b> 131°F (55°C) Ambient Temperature 77°F (25°C)
<b>Isolation:</b> Class 1	<b>Drip Proof:</b> IP23
<b>Watts:</b> 900W (450W w/ heater off)	<b>RPM:</b> 16,000 - 29,000, Adjustable
<b>Model, Voltage &amp; Amps:</b>	<b>Mounting:</b> Surface
HD0923-09 110/120 Volts 4.17-8.33 Amps	<b>Dimensions:</b> 5.98" W x 10.56" H x 3.94" D
HD0924-09 208/220 Volts 1.91-3.82 Amps	<b>Weight:</b> 8.40lbs



### EcoStorm High Speed Hand Dryer - Surface or Recess Mount

<b>Material:</b> Stainless Steel	<b>Motor Type:</b> 3/4HP, 500W brush type, dual ball bearings
<b>Operating Airflow:</b> 17,752 LFM, Adjustable	<b>Sound Level:</b> 63.5dB
<b>Thermal Protection:</b> Motor Shuts Off at 221°F (105°C) Heater Shuts Off at 282°F (139°C)	<b>Air Output Temperature:</b> 131°F (55°C) Ambient Temperature 77°F (25°C)
<b>Isolation:</b> Class 1	<b>Drip Proof:</b> IPX1
<b>Watts:</b> 1000W	<b>RPM:</b> 29,000, Adjustable
<b>Model, Voltage &amp; Amps:</b>	<b>Mounting:</b> Surface or Recessed
HD0940-09 110/120 Volts 8.4-10.5 Amps	<b>Dimensions:</b> 9.84" W x 7.09" H x 5.45" D   8.40lbs (surface) 10.71" W x 15.51" H x 5.56" D   15.40lbs (recessed)
HD0941-09 220/240 Volts 4.2-5.5 Amps	
HD0940-17 110/120 Volts 8.4-10.5 Amps	
HD0940-17H 110/120 Volts 8.4-10.5 Amps	*H Model includes a HEPA Filter
HD0941-17 220/240 Volts 4.2-5.5 Amps	
HD0945-09 110/120 Volts 8.4-10.5 Amps	



### High Grade Fire-Retardant ABS Hand Dryer

<b>Material:</b> ABS Plastic	<b>Motor Type:</b> 1/8 HP, Brushless, 100W
<b>Operating Airflow:</b> 3,242 LFM	<b>Sound Level:</b> 55±3dB
<b>Thermal Protection:</b> Heater Shuts Off at 286°F (141°C)	<b>Air Output Temperature:</b> 136°F (58°C) Ambient Temperature 68°F (20°C)
<b>Isolation:</b> Class 1	<b>Drip Proof:</b> IPX1
<b>Watts:</b> 1800W	<b>RPM:</b> 2,850
<b>Model, Voltage &amp; Amps:</b>	<b>Mounting:</b> Surface
HD0903-17 110/120 Volts 13.8-15 Amps	<b>Dimensions:</b> 10.50" W x 8.75" H x 6.75" D   8.40lbs

### MOUNTING HEIGHTS - BluStorm

from bottom of dryer to the finished floor

Men	50"
Women	47"
Children (4-7)	35"
Children (8-10)	39"
Children (11-13)	43"
Children (14-16)	47"
Accessible	40"

### MOUNTING HEIGHTS - EcoStorm

from bottom of dryer to the finished floor

Men	40"
Women	38"
Children (4-7)	32"
Children (8-10)	34"
Children (11-13)	36"
Children (14-16)	38"
Accessible	34"



**Caution Wet Floor Sign**

model	CS0702
dimensions (in)	11.50w x 24h x 20.50d
weight (lb)	1.33

19



**Sanitary Napkin Container**

model	CS000250
dimensions (in)	8.00w x 11.25h x 4.50d
weight (lb)	3.16

09 17



**Plastic Toilet Seat Cover Dispenser**

model	TS0143
dimensions (in)	18.24w x 15h x 1.91d
weight (lb)	.70

16



**Brushed Chrome Toilet Seat Cover Dispenser**

model	TS0142
dimensions (in)	16w x 11.75h x 2.50d
weight (lb)	2.16

11



**Protective Plastic Face Shield**

model	CS0509-23
dimensions (in)	9.00w x 10h x 10d
weight (lb)	less than .5 lb

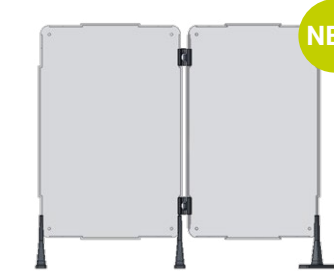

**Sneeze Guard Panel Starter Kit**

model	CS0507-23
dimensions (in)	16w x 24h x .375d
weight (lb)	2.80

Kit includes 2 panels, 3 legs, 2 clips, 2 hinges



**Disposable Urinal Mat**

model	FM0148
dimensions (in)	17.75w x 20.50h x .03d
weight (lb)	.66

21



**Disposable Commode Mat**

model	FM0149
dimensions (in)	23w x 21.25h x .03d
weight (lb)	.83

21



**Wall Mount Drip Tray**

model	SP0503
dimensions (in)	4.50w x 6.75h x 4.00d
weight (lb)	.5

21



**18" and 24" Metal Grab Bars**

model	CS0718
dimensions (in)	21.125w x 3.125h x 3.125d
weight (lb)	1.50

model	CS0724
dimensions (in)	27.125w x 3.125h x 3.125d
weight (lb)	1.83

09



**30" Metal Grab Bars**

model	CS0730
dimensions (in)	33.125w x 3.125h x 3.125d
weight (lb)	2.00

09





### Mens Restroom Sign

model	IS1001
dimensions (in)	6w x 8h x .25d
weight (lb)	.5

15



### Womens Restroom Sign

model	IS1003
dimensions (in)	6w x 8h x .25d
weight (lb)	.5

15



### Unisex Restroom Sign

model	IS1005
dimensions (in)	6w x 8h x .25d
weight (lb)	.5

15



### Mens Accessible Restroom Sign

model	IS1002
dimensions (in)	6w x 8h x .25d
weight (lb)	.5

15 16



### Womens Accessible Restroom Sign

model	IS1004
dimensions (in)	6w x 8h x .25d
weight (lb)	.5

15 16



### Unisex Accessible Restroom Sign

model	IS1006
dimensions (in)	6w x 8h x .25d
weight (lb)	.5

15 16



### Boys Accessible Restroom Sign

model	IS1007
dimensions (in)	6w x 8h x .25d
weight (lb)	.5

15



### Girls Accessible Restroom Sign

model	IS1008
dimensions (in)	6w x 8h x .25d
weight (lb)	.5

15



### No Smoking Sign

model	IS1010
dimensions (in)	6w x 8h x .25d
weight (lb)	.5

15



### Exit Sign

model	IS1011
dimensions (in)	9w x 6h x .25d
weight (lb)	.5

15



### Employees Must Wash Hands Notice Sign

model	IS8001
dimensions (in)	10w x 7h x .25d
weight (lb)	.5

15 16 18 22





### Counter Top Full Fold Napkin Dispenser

model	ND0071
dimensions (in)	7.50w x 5.125h x 11.75d
weight (lb)	3.85
capacity	300 Full Fold Napkins

13



### Table Top Low Fold Napkin Dispenser

model	ND0045
dimensions (in)	4.00w x 5.50h x 4.75d
weight (lb)	1.40
capacity	180 Low Fold Napkins

13



### Tabletop Display Stand

model	SF0301
dimensions (in)	7.00w x 18.75h x 6.25d
weight (lb)	1.00

16



### Metal Floor Display Stand

model	SF0320
dimensions (in)	6.00w x 48.00h x 14.00d
weight (lb)	15.00

16 17



### Modular Plastic Display Stand

model	SF0503
dimensions (in)	17.50w x 15.13h x 17.50d
weight (lb)	6.20

16



### Universal Metal Display Stand

model	SF0508
dimensions (in)	15.00w x 50.55h x 15.00d
weight (lb)	23.00

16

Palmer Fixture Napkin Dispenser are constructed of heavy gauge brushed steel, and feature non-marking rubber feet to protect surfaces. All napkin dispensers are designed for single napkin dispensing to help prevent waste. Counter Top models are top loading, while Table Top models load from both sides.



## DISPENSER KEYS

For more information on Replacement Keys, visit [www.palmerfixture.com](http://www.palmerfixture.com) or call **1-800-558-8678**. Please reference the individual product information tables to see which key fits a specific dispenser.

1 SP0100-00



2 SP0102-00



3 SP0103-00



4 SP0104-00



5 SP0105-00



6 SP0106-00



7 SP0101-00



8 SP0108-00



9 SP0107-00



10 SP0110-00



11 SP0111-00



13 SP0113-00



14 SP0130-00



15 SP0131-00



16 SP0132-00



17 SP0134-00



## REPLACEMENT DISPENSER PARTS

Replacement parts are available for most Palmer Fixture dispensers, please call **1-800-558-8678** for replacement part information.

For Questions, Customer Service, Product or Warranty Information, Please Call: 1-800-558-8678

## WARRANTY INFORMATION

Palmer Fixture Company LLC. warranties for a period of twelve (12) months from the date of sale that dispensers manufactured by Palmer shall be free from defects in workmanship and material and shall conform to Palmer's specifications.

The warranties set forth in this paragraph shall be in effect only if:

- 1) Written notice of a dispenser failure is provided to Palmer within the warranty period.
- 2) The dispenser has not been altered, tampered with, or modified in any way.
- 3) The dispenser failure is not caused by damage in transit, negligence, abuse, abnormal usage, misuse, accidents, or improper maintenance.

The dispensers manufactured by Palmer Fixture do not guarantee that all types of paper products will work. As a result, it is the responsibility of the buyer to determine the dispenser's suitability for the paper products used.

Palmer's obligation under this warranty is limited to and shall be fully discharged by repairing or replacing, F.O.B. Green Bay, WI, the dispenser or any part of the dispenser which is determined by Palmer not to be in conformity with the above warranty. If requested by Palmer, the defective dispenser or parts thereof, are to be returned to Palmer, transportation prepaid.

Palmer reserves the right to make changes in design and/or improvements in its products at any time without the obligation to make such changes or improvements in its products previously manufactured.

THE WARRANTIES FURNISHED BY PALMER HEREIN ARE IN LIEU OF ANY OTHER WARRANTIES OR GUARANTIES EXPRESSED OR IMPLIED, INCLUDING THE WARRANTIES OF MERCHANTABILITY AND FITNESS FOR A PARTICULAR PURPOSE.

NOT WITHSTANDING ANYTHING PROVIDED IN THE ABOVE WARRANTY OR IN ANY OTHER AGREEMENT BETWEEN PALMER AND BUYER, PALMER SHALL NOT BE LIABLE FOR ANY CONSEQUENTIAL, PROPERTY OR SPECIAL DAMAGES INCLUDING, BUT NOT LIMITED TO, ANY LOSS OF USE OR DOWNTIME WHICH BUYER MAY EXPERIENCE.

**Hand Dryer Warranties vary in length.**



Toll-Free: 800.558.8678 | [www.palmerfixture.com](http://www.palmerfixture.com) | [info@palmerfixture.com](mailto:info@palmerfixture.com)