

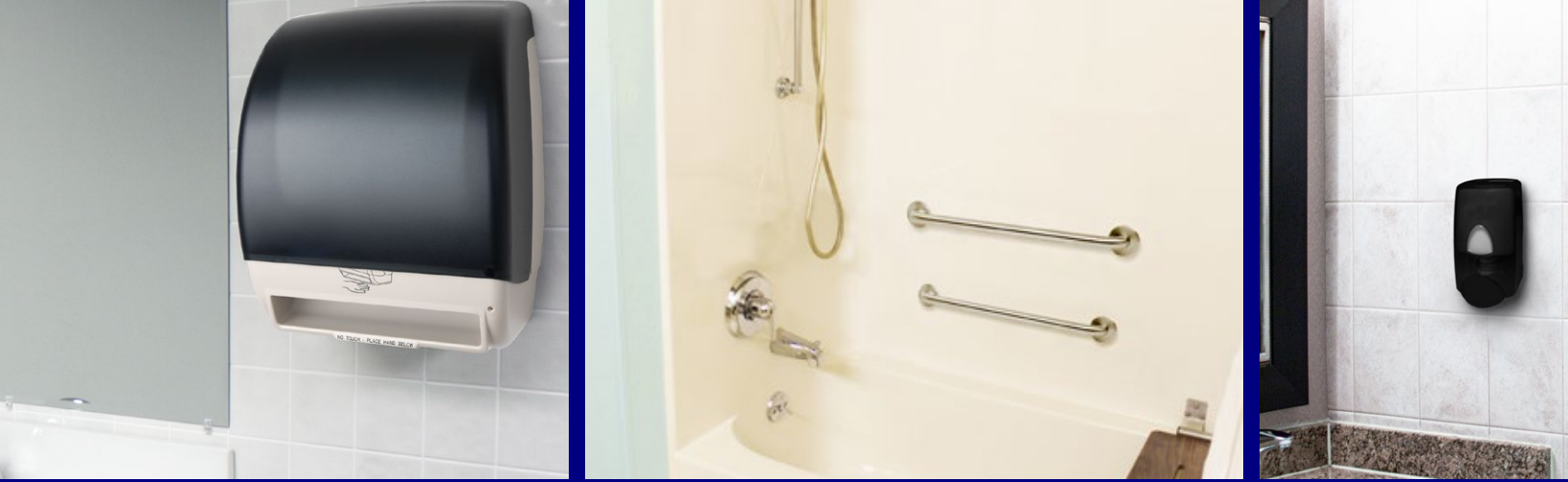

- 2025 -
P R O D U C T
C A T A L O G

DEPENDABLE DISPENSERS & FLOOR CARE SOLUTIONS



CATALOG CONTENTS

- 4** Palmer Fixture History
- 6** Catalog Key / LEED
- 7** ADA Compliant Products
- 8** Touchless Roll Towel Dispensers
- 10** Roll Towel Dispensers
- 12** Folded Towel Dispensers
- 14** Pad Printing
- 15** Universal Advantage
- 16** Jumbo Tissue Dispensers



- 18** **Standard Tissue Dispensers**
- 20** **Bulk Soap Dispensers**
- 22** **EcoTap Series**
- 24** **High Speed Hand Dryers**
- 26** **Safety & Maintenance**
- 28** **Signs**
- 30** **Napkin Dispensers**
- 31** **Display Stands**
- 32** **Replacement Keys / Warranty Information**
- 34** **Brush Preview**

THE HISTORY

— OF PALMER FIXTURE —



1907

FOUNDED

The Palmer Company was founded by J. Frederick Palmer in Waukesha, WI

FIRST PATENT

Palmer patented the "Roll Paper Holder" - which dispensed one sheet of tissue at a time to prevent waste.

1915

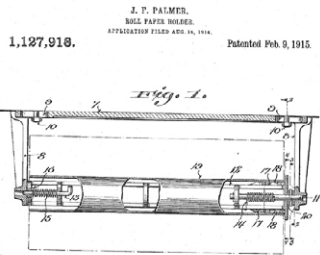

Aug. 18, 1931. J. F. PALMER 1,819,382

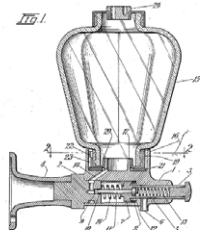

1928

SOAP DISPENSER

Palmer Fixture patented a Liquid Soap Dispenser in the popular "globe" style

POWER ACTUATED SOAP DISPENSER

Palmer Fixture patented a power actuated soap dispenser - one of the first of its kind!

1939

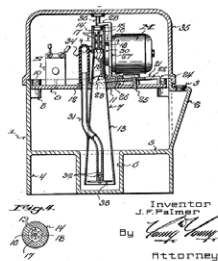

1945

FIRST ISSA

Palmer participated in their 1st ISSA Trade Show. Palmer has been an exhibitor for 70 consecutive years.

ABOUT PALMER FIXTURE

At Palmer Fixture, we are devoted to providing you with a number of solutions based on your specific needs, along with our product offerings and expertise. As we continue to serve as a leader of the industry, we are continuously working on new products and ways to make your life cleaner, greener, and more hygienic.

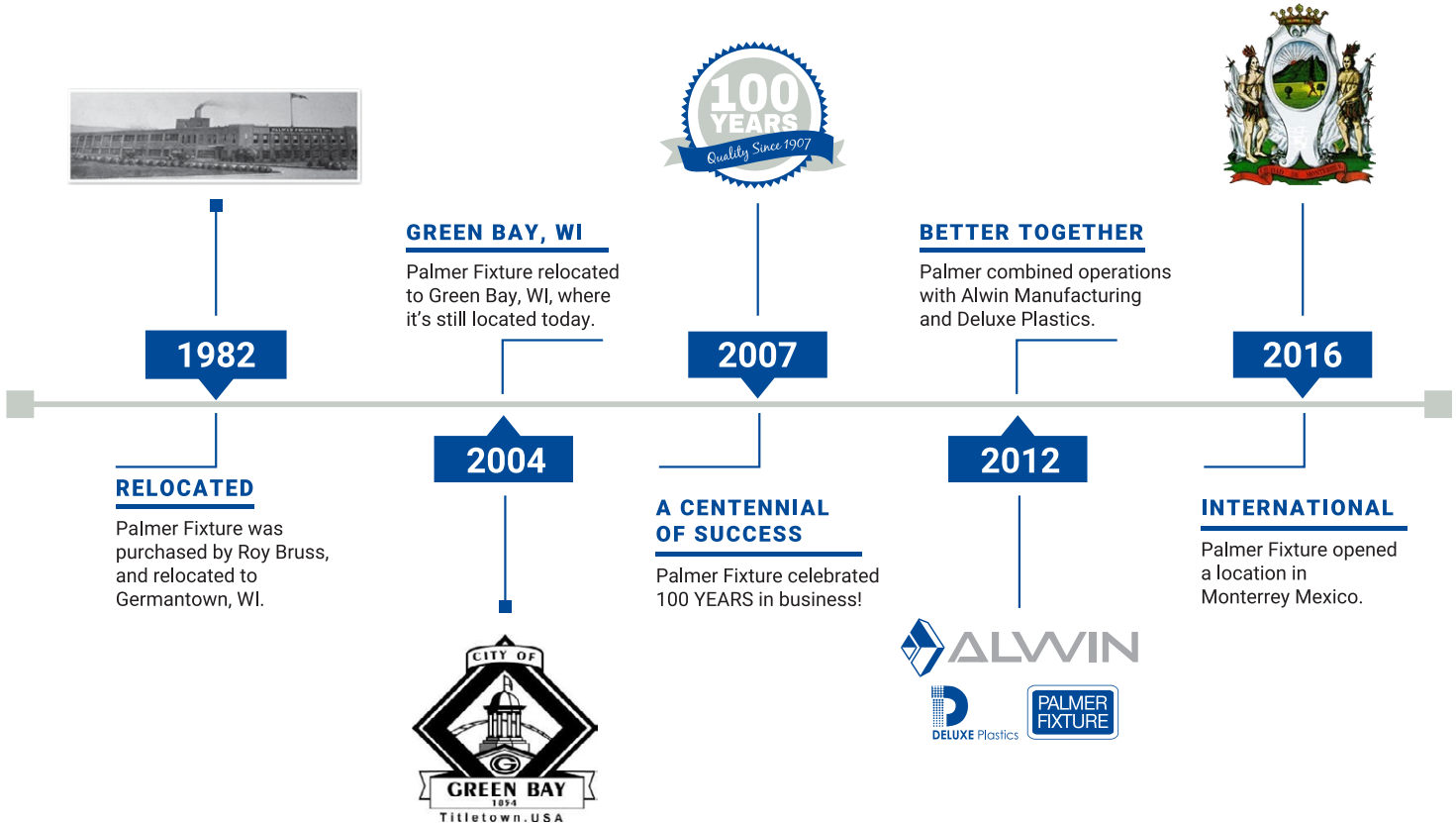

Palmer Fixture, for over 100 years, has been committed to providing the most competitive value-added dispensing systems available. Palmer Fixture offers a variety of items from the traditional metal crank dispensers to our innovative automatic touchless dispensers and hand dryers. We are constantly expanding our product lines as we continue looking for more ways to satisfy our customers. Most of our products are made in the USA and are subject to strict quality control processes. Through extensive research and development, Palmer Fixture Company has maintained a world wide reputation for product excellence since 1907.

PRODUCT CATALOG KEY

Watch for these icons throughout the catalog to indicate product details:



Eco-Friendly Product



ADA Compliant Product



Pad Printing Available



Product Made in the U.S.A.

Product Color Key:



(01) Dark Translucent



(11) Brushed Chrome



(18) Green



(02) Black Translucent



(13) Brushed Steel



(19) Yellow



(03) White Translucent



(15) Blue



(21) Grey



(08) Platinum



(16) Black



(22) Red



(09) Brushed Stainless



(17) White

LEED CREDIT INFORMATION

What is LEED?

LEED, or Leadership in Energy & Environmental Design, is a green building certification program that recognizes best-in-class building strategies and practices. To receive LEED certification, building projects satisfy prerequisites and earn points to achieve different levels of certification. Prerequisites and credits differ for each rating system, and teams choose the best fit for their project.



Which Palmer Fixture Products earn credits?

The BluStorm® High Speed Hand Dryer (pg. 12) earns LEED Credits for EAc1: Optimize Energy Performance and EAp2: Minimum Energy Performance

The EcoStorm® High Speed Hand Dryer (pg. 14) earns LEED Credits for EAc1: Optimize Energy Performance and EAp2: Minimum Energy Performance

For more information on the LEED Program and detailed requirements, visit www.usgbc.org/leed

ADA COMPLIANT PRODUCTS

The Americans with Disabilities Act (ADA) defines the accessible requirements for the design and construction of washroom space in the United States. Detailed below are examples of the ADA installation requirements for hand dryers.

**As for the visually impaired,
Rule 4.4.1 states:**

Objects projecting from walls (for example, telephones) with their leading edges between 27 and 80 inches (685 mm and 2020 mm) above the finished floor shall protrude no more than 4 inches (100 mm) into walks, halls, corridors, passageways, or aisles. Objects mounted with their leading edges at or below 27 inches (685 mm) above the finished floor may protrude any amount.

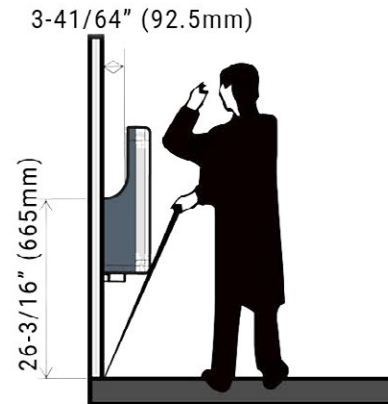

**According to ADA Regulation 4.2.5,
concerning forward reach:**

If the clear floor space only allows forward approach to an object, the maximum high forward reach allowed shall be 48 inches (1220 mm). The minimum for low forward reach is 15 inches (380 mm).

ADA Accessibility Guidelines (as measured from finished floor)	
Forward Reach Ranges - Unobstructed	
48" H max.	15" H min.

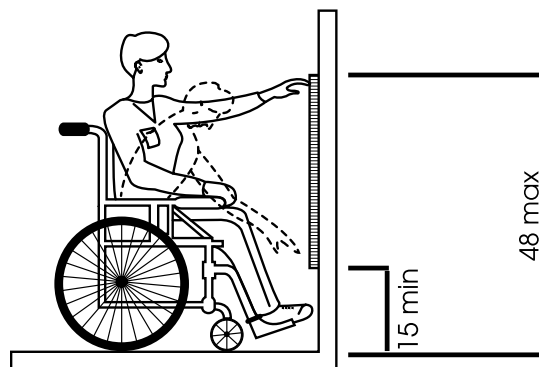

The above information is for informational purposes only and not intended to be an alternative to the ADA Accessibility Guidelines or specifications. For complete information on current ADA requirements, visit www.ada.gov



NEW

Premium Electronic Hands Free Roll Towel Dispenser

model	TD0265
dimensions (in)	12.112w x 16.598h x 9.652d
weight (lb)	5.80
key type	1
capacity	8"W x 8"D Roll Towel
batteries	4x "D" LR20 Alkaline

02 09



NEW

Premium Touchless Roll Towel Dispenser w/ Butler Feature

model	TD0264
dimensions (in)	12.28w x 16.15h x 9.57d
weight (lb)	5.00
key type	1
capacity	8"W x 8"D Roll Towel
batteries	4x "D" LR20 Alkaline

02 09



NEW

Premium Mechanical Hands-Free Roll Towel Dispenser

model	TD0204
dimensions (in)	12.28w x 17.31h x 9.61d
weight (lb)	6.00
key type	1
capacity	8"W x 8"D Roll Towel

02 09



Electronic Touchless Towel Dispenser

model	TD0235
dimensions (in)	11.39w x 13.21h x 8.58d
weight (lb)	4.00
key type	1
capacity	8"W x 8"D Roll Towel
batteries	4x "D" LR20 Alkaline

02 03



TOP
SELLER

Mechanical Auto-Cut Roll Towel Dispenser

model	TD0201
dimensions (in)	11.43w x 15.02h x 8.98d
weight (lb)	4.50
key type	1
capacity	8"W x 8"D Roll Towel

02 03



6"
ROLL

Electronic Hands-Free Roll Towel Dispenser

model	TD0234
dimensions (in)	11.52w x 11.42h x 7.69d
weight (lb)	3.65
key type	1
capacity	8"W x 6"D Roll Towel
batteries	4x "D" LR20 Alkaline

02 03



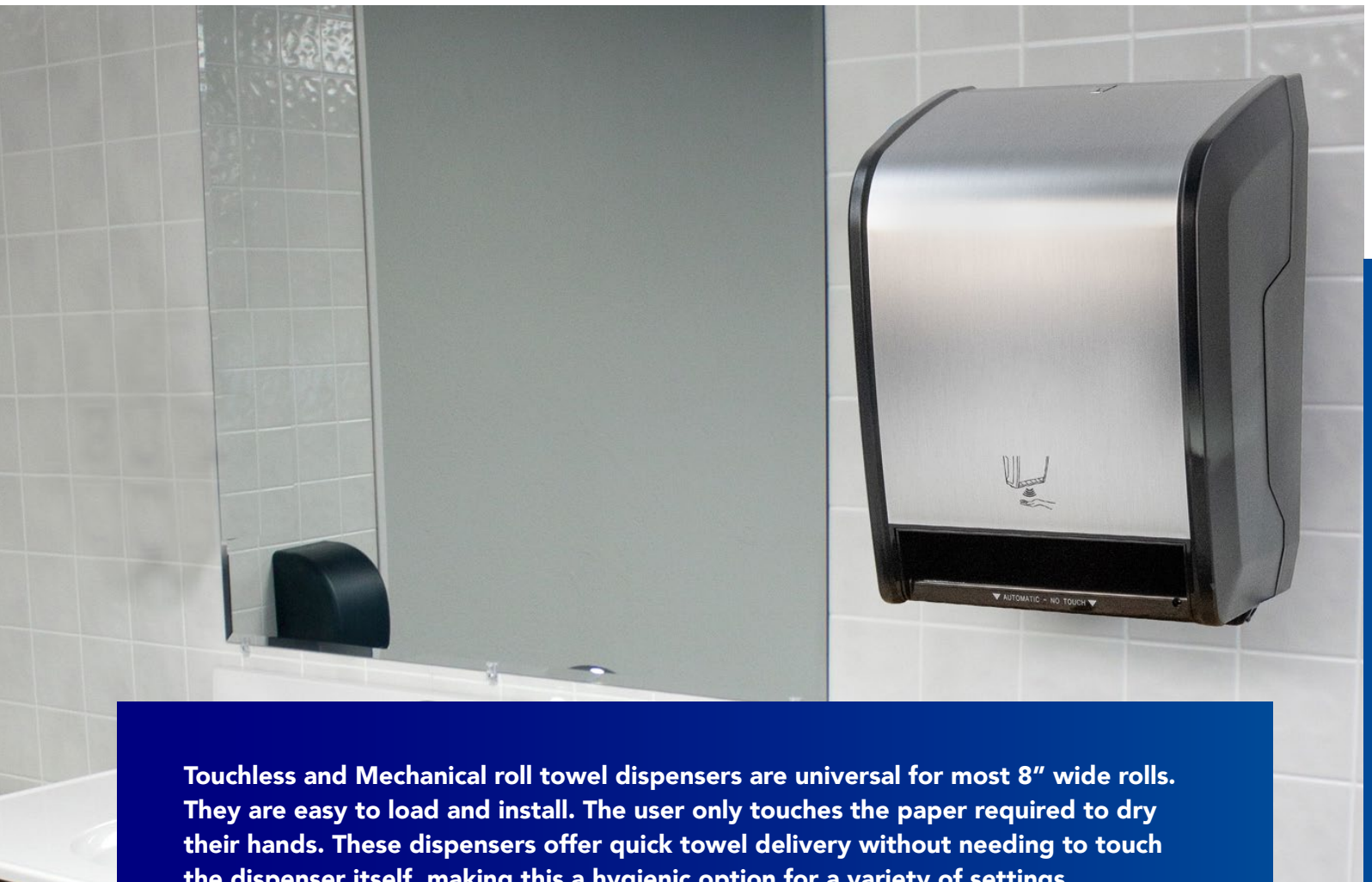

Touchless and Mechanical roll towel dispensers are universal for most 8" wide rolls. They are easy to load and install. The user only touches the paper required to dry their hands. These dispensers offer quick towel delivery without needing to touch the dispenser itself, making this a hygienic option for a variety of settings.



Mechanical Hands-Free Roll Towel Dispenser

model	TD0202
dimensions (in)	11.39w x 12.34h x 7.12d
weight (lb)	4.05
key type	1
capacity	8"W x 6"D Roll Towel

02 03



Electronic Touchless Roll Towel Dispenser

model	TD0245
dimensions (in)	12.27w x 15.20h x 9.47d
weight (lb)	4.60
key type	1
capacity	8"W x 8"D Roll Towel
batteries	4x "D" LR20 Alkaline

Electronic Touchless Roll Towel Dispenser w/ AC

model	TD0246*
weight (lb)	5.00

* Includes AC Adaptor - no batteries

* Only available in 01 or 02 color

02 03





**ROLL TOWEL
DISPENSERS**



Palmer Fixture universal roll paper towel dispensers offer a smooth and quick delivery and provide an excellent value in roll towel dispensing. Not only can these dispensers be used in a variety of settings, they are easy to use and maintain. All of our Roll Towel Dispensers are Made in the U.S.A.!



Auto-Transfer Push Bar Roll Towel Dispenser (Metal Back)

model	TD0215
dimensions (in)	10.56w x 15.67h x 8.64d
weight (lb)	6.00
key type	1
capacity	8"W x 8"D Roll Towel

02 03



Auto-Transfer Push Bar Roll Towel Dispenser (Plastic Back)

model	TD0216
dimensions (in)	10.74w x 15.49h x 8.96d
weight (lb)	4.75
key type	1
capacity	8"W x 8"D Roll Towel

02 03



Compact Lever Roll Towel Dispenser

model	TD0220
dimensions (in)	11.88w x 13.71h x 9.16d
weight (lb)	3.75
key type	1
capacity	8"W x 8"D Roll Towel

02 03



Self-Adjusting Centerpull Roll Towel Dispenser

model	TD0255
dimensions (in)	10.13w x 12.45h x 10.13d
weight (lb)	2.45
key type	1
capacity	9"W x 9"D Centerpull Towel

02





Enhance your image by showing awareness for your patrons' hygiene and safety, with the **Mini-Fold Towel Dispenser** from Palmer Fixture. Reduce cost and conserve paper with a controlled delivery of one sheet at a time. Starter kits available include 2 Dispensers and 6 Packs of Paper.



Mini-Fold Towel Dispenser

model	TD0177
dimensions (in)	4.00w x 11.125h x 5.625d
weight (lb)	0.95
key type	1
capacity	500 Mini-Fold Towels

Starter Packs & Paper Refills

model	TD0178
paper	RP8096-17

Starter Pack includes 2 Towel Dispensers & 6 Packs of Paper

02



Premium Multi/C-Fold Towel Dispenser

model	TD0189
dimensions (in)	12.072" w x 16.897" h x 4.607" d
weight (lb)	2.50
key type	1
capacity	500 Multi-Fold Towels or 400 C-Fold Towels

02 09



Plastic Multifold Towel Dispenser

model	TD0179
dimensions (in)	11.00w x 16.07h x 4.50d
weight (lb)	2.00
key type	1
capacity	540 Multifold Towels

02 03



Mini Multifold Towel Dispenser

model	TD0171
dimensions (in)	11.00w x 10.80h x 4.50d
weight (lb)	1.40
key type	1
capacity	400 Multifold Towels

02 03





Palmer Fixture offers a variety of folded towel options that are available to use with our dispensers – Multifold, C-fold or Single Fold. All dispensers are ADA compliant when installed to the correct specifications. Folded towel dispensers are great options for medical facilities and restaurant kitchens.



Multifold/C-Fold Towel Dispenser

model	TD0175
dimensions (in)	11.375w x 15.22h x 5.00d
weight (lb)	3.50
key type	1
capacity	540 Multifold Towels OR 350 C-Fold Towels

01 03



Multi-Fold/C-Fold Towel Dispenser

model	TD0170
dimensions (in)	11.125" w x 15.25" h x 4" d
weight (lb)	4.45
key type	1
capacity	540 Multifold Towels OR 350 C-Fold Towels

09



Metal Single Fold Towel Dispenser

model	TD0091
dimensions (in)	11.74w x 9.23h x 5.59d
weight (lb)	4.40
key type	1
capacity	450 Single Fold Towels

17



ADD A SPLASH OF COLOR!



PAD PRINTING

Palmer Fixture offers several customizable dispensers. Your logo will surely stand out when printed in our **standard metallic silver ink***. Logos are printed on the bottom center of the dispenser cover.

The logo can be up to 2.5 inches wide, with a height of up to 1.5 inches. Our Made in the U.S.A. dispensers provide a consistent, first-class quality offering to you and your customers.

Add your logo today for a one of a kind look!

Look for the  throughout this catalog to indicate which dispensers are available for customization.



How to Get YOUR Logo on Palmer Dispensers

Contact us via email at info@palmerfixture.com or by calling **1-800-558-8678** for a quote.

*colors other than standard silver may incur additional charges

UNIVERSAL ADVANTAGE

A QUICK GUIDE TO CHOOSING UNIVERSAL DISPENSERS

CHOOSE YOUR PAPER

Universal Dispensers provide maximum flexibility when purchasing **Universal Roll Towels**. Purchase where you want, whenever you need it.

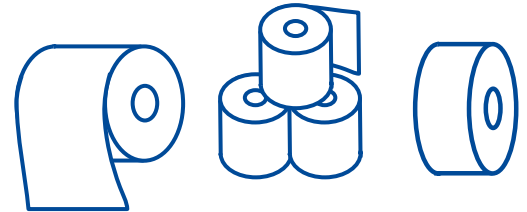

AVOID COSTLY CONTRACTS

Choosing **Universal Dispensers** avoids long term contracts, and may save you between 25-50% when purchasing **Universal Roll Towels**.

BE YOUR OWN BRAND

Brand your new **Universal Dispensers** with the Palmer Fixture Pad Printing option! Not only is Pad Printing easy and affordable, it's also a great way to advertise your company.



OVER 30 DISPENSER MODELS TO CHOOSE FROM



Premium Twin 9" Jumbo Tissue Dispenser

model	RD0057
dimensions (in)	21.208" w x 11.749" h x 4.08" d
weight (lb)	3.40
key type	1
capacity	Two 9" Jumbo Tissue

02 09



Premium Single 9" Jumbo Tissue Dispenser

model	RD0056
dimensions (in)	11.708" w x 11.727" h x 4.08" d
weight (lb)	2.00
key type	1
capacity	9" Jumbo Tissue

02 09



Single 12" Senior Jumbo Tissue Dispenser

model	RD0038F
dimensions (in)	13.75w x 14.125h x 5.0625d
weight (lb)	3.20
key type	1
capacity	12" Jumbo Tissue

02



Single 13" Jumbo Tissue Dispenser

model	RD0330
dimensions (in)	16.50w x 14.30h x 4.89d
weight (lb)	2.35
key type	1
capacity	13" Jumbo Tissue

02



Single 12" Senior Jumbo Tissue Dispenser

model	RD0059F
dimensions (in)	15w x 15.20h x 5.50d
weight (lb)	2.60
key type	1
capacity	12" Jumbo Tissue

02



Single 9" Jumbo Tissue Dispenser w/ Stub Roll

model	RD0024
dimensions (in)	16.21w x 12.05h x 5.36d
weight (lb)	2.60
key type	1
capacity	9" Jumbo Tissue + Stub

02 03





Twin 9" Jumbo Tissue Dispenser

model	RD0027*
dimensions (in)	20.23w x 11.71h x 5.37d
weight (lb)	2.85
key type	1
capacity	Two 9" Jumbo Tissue

*Add 'F' to add a 2-1/4" - 3-3/8" Core Adaptor

02 03



Single 9" Jumbo Tissue Dispenser

model	RD0026
dimensions (in)	11.47w x 11.22h x 5.37d
weight (lb)	1.65
key type	1
capacity	9" Jumbo Tissue

*Add 'F' to add a 2-1/4" - 3-3/8" Core Adaptor

02 03



Single 9" Jumbo Tissue Dispenser

model	RD0016
dimensions (in)	10.31w x 11.81h x 4.50d
weight (lb)	1.60
key type	1
capacity	9" Jumbo Tissue

02 17



Twin 9" Jumbo Tissue Dispenser

model	RD0327
dimensions (in)	19.69w x 11.18h x 5.12d
weight (lb)	5.15
key type	1
capacity	Two 9" Jumbo Tissue

09



Single 10" Senior Jumbo Tissue Dispenser

model	RD0346
dimensions (in)	10.63w x 10.63h x 4.65d
weight (lb)	2.80
key type	13
capacity	10" Jumbo Tissue

09 16



Single 14" Jumbo Tissue Dispenser

model	RD0348
dimensions (in)	14.09w x 14.25h x 4.65d
weight (lb)	4.05
key type	13
capacity	14" Jumbo Tissue

09 16 17



Premium Two-Roll Standard Tissue Dispenser

model	RD0058
dimensions (in)	7.08w x 14.78h x 7.31d
weight (lb)	2.20
key type	1
capacity	Two Standard Core Tissue

***Add 'G' to any model for the Micro Core option**

02 09



Premium Quad Standard Tissue Dispenser

model	RD0445
dimensions (in)	12.91w x 14.78h x 7.31d
weight (lb)	3.20
key type	1
capacity	Four Standard Core Tissue

***Add 'G' to any model for the Micro Core option**

02 09



Two-Roll Standard Tissue Dispenser

model	RD0025
dimensions (in)	6.02w x 13.13h x 6d
weight (lb)	2.10
key type	1
capacity	Two Standard Tissue Rolls

01 03



Mini Twin Standard Tissue Dispenser

model	RD0321*
dimensions (in)	11.86w x 7.32h x 5.48d
weight (lb)	1.60
key type	1
capacity	Two Standard Tissue Rolls

***Add 'G' to any model for the Micro Core option**

02 03



4-Roll Carousel "Turnado" Tissue Dispenser

model	RD0044
dimensions (in)	13.11w x 14.93h x 6.08d
weight (lb)	3.55
key type	2
capacity	Four Standard Tissue Rolls

02



Stainless Steel Two-Roll Standard Tissue Dispensers

model	RD0325
dimensions (in)	5.83w x 13.125h x 5.83d
weight (lb)	3.30
key type	1
capacity	Two Standard Tissue Rolls

09



Two-Roll Standard Tissue Dispenser

model	RD0028
dimensions (in)	6.02w x 13.04h x 6.16d
weight (lb)	1.75
key type	1
capacity	Two Standard Tissue Rolls

01 03



7.5" Mini Twin Standard Core Tissue Dispenser

model	RD0323
dimensions (in)	16.611w x 9.806h x 5.477d
weight (lb)	2.50
key type	1
capacity	Two 7.5" Standard Core Tissue

***Add 'G' to any model for the Micro Core option**

02 03



Metal Single Roll Standard Tissue Dispenser

model	RD0381
dimensions (in)	6.00w x 4.25h x 2.75d
weight (lb)	0.42
key type	NA
capacity	One Standard Tissue Roll

12

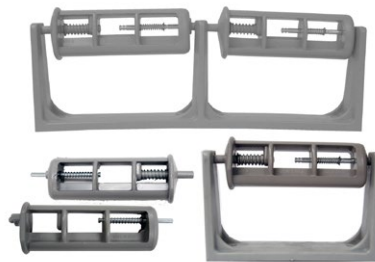

Governor & No Waste Tissue Spindles

model (single)	RD0401 or RD0404
dimensions (in)	6.50w x 4.50h x 1.75d
capacity	One Standard Tissue Roll
model (double)	RD0421 or RD0424
dimensions (in)	12.50w x 4.50h x 1.75d
capacity	Two Standard Tissue Rolls

***Add 'U' to any model for the Free Turning option**

model (spindle)	RS0201 or RS0402
dimensions (in)	6.500w x 4.50h x 1.75d

21



Electronic Touchless Bulk Liquid Dispenser

model	SE0900
dimensions (in)	5.00w x 10.50h x 4.75d
weight (lb)	1.80
key type	15
capacity	1000mL Bulk Liquid Soap
batteries	6x "AA" Alkaline

16 17



Manual Bulk Liquid Soap Dispenser

model	SD0927
dimensions (in)	4.33w x 7.68h x 4.33d
weight (lb)	.67
key type	17
capacity	1000mL Bulk Liquid Soap

02



Manual Bulk Liquid Soap Dispenser

model	SD0942
dimensions (in)	5.25w x 9.875h x 4.50d
weight (lb)	1.54
key type	NA
capacity	1000mL Bulk Liquid Soap

16 17



Electronic Touchless Bulk Foam Dispenser

model	SF0900
dimensions (in)	5.00w x 10.50h x 4.75d
weight (lb)	1.80
key type	15
capacity	1000mL Bulk Foam Soap
batteries	6x "AA" Alkaline

16 17



Electronic Bulk Foam Dispenser

model	SF2150
dimensions (in)	5.75w x 10.43h x 4.33d
weight (lb)	1.95
key type	11
capacity	1000mL Bulk Foam Soap
batteries	4x "C" Alkaline

08 16 17



Manual Bulk Foam Soap Dispenser

model	SF0942
dimensions (in)	5.25w x 9.875h x 4.50d
weight (lb)	1.54
key type	NA
capacity	1000mL Bulk Foam Soap

16 17





Palmer Fixture Bulk Liquid or Foam Soap Dispensers are available in Electronic Touchless or Manually operated models. All units are refillable and designed to be efficient. The Bulk Soap Dispensers are refillable with quality bulk liquid soaps.



Manual Bulk Foam Dispenser

model	SF2111
dimensions (in)	4.80w x 10.71h x 5.04d
weight (lb)	1.15
key type	10
capacity	1000mL Bulk Foam Soap



HAND
DRYERS

TOUCHFREE SOPHISTICATION

Introducing the EcoTap Trio
FOAM SOAP | FAUCET | HAND DRYER

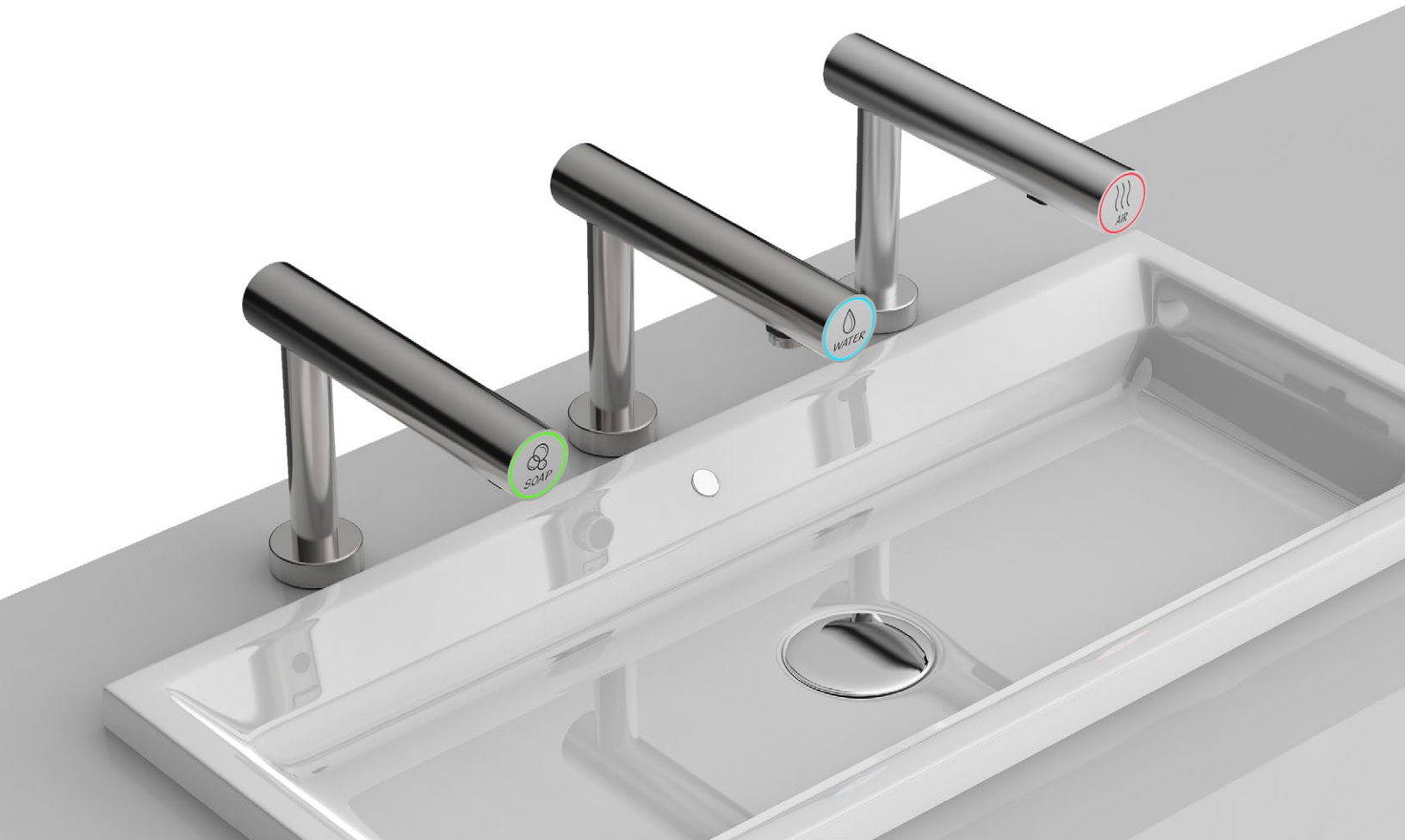

**WALL MOUNT OPTION
ALSO AVAILABLE!**

SPECIAL ORDER

EcoTap Hand Dryer

Material: Stainless Steel

Motor Type: Adjustable brush type, dual ball bearings

Operating Airflow: 16,535-19,882 LFM, Adjustable

Sound Level: MIN 68.5dB to 70.5dB MAX @1m

Thermal Protection:

Thermostat Shuts Off 203°F (95°C)
Thermal Cut-Off at 185°F (85°C)

Air Output Temperature:

122°F (57°C)
Ambient Temperature 77°F (25°C)

Isolation: Class 1

Drip Proof: IP35

Watts: 500W

RPM: 22,000-29,000, Adjustable

Model, Voltage & Amps:

HD0935-09	110/120 Volts	7.6-8.4 Amps
HD0936-09 (special order)	220/240 Volts	3.8-4.2 Amps

Mounting: Surface Spout with Undermount Motor

Dimensions: 1.97" W x 6.69" H x 8.66" D (spout)
12.05" W x 7.60" H x 5.85" D (motor)

Wall Mount (Special Order): HD0935-09W

EcoTap Automatic Faucet

Material: Stainless Steel

Power Source: AC

Sensing Range: 4.72" ± .78", Adjustable

Auto Shut-Off: 1 Minute

Operating Water Pressure: 10~100 PSI

Flowing Volume: .05-1 L/Minute

Drip Proof: IP35

Mounting: Surface Spout

Model: AF0304-09

Dimensions: 1.97" W x 6.69" H x 8.66" D (spout)

Wall Mount (Special Order): AF0304-09W

EcoTap Foam Soap Dispenser

Material: Stainless Steel

Power Source: AC

Sensing Range: 4.72" ± .78", Adjustable

Capacity: 1500 mL Foam Soap

Pump Life Cycle: 100K

Mechanism Life Cycle: 500K

Drip Proof: IP35

Mounting: Surface Spout

Model: SD1500-09 (liquid available for special order)

Dimensions: 1.97" W x 6.69" H x 8.66" D (spout)

Wall Mount (Special Order): SD1500-09W

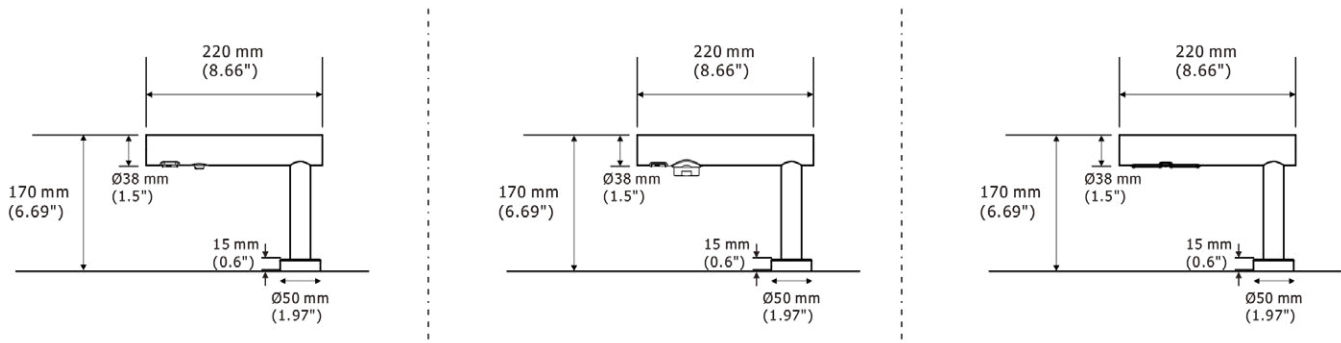

Recommended Distance Between Units: 7.09" (180mm)



HAND DRYERS



iStorm2 High Speed Hand Dryer

Material: Polycarbonate ABS (ION+)	Motor Type: 1HP, 350-700 Watts
Operating Airflow: 19,476 LFM, Adjustable	Sound Level: 65dB - 78dB MAX
Thermal Protection: Motor Shuts Off at 275°F (135°C) Heater Shuts Off at 288°F (142°C)	Air Output Temperature: 140°F (60°C) Ambient Temperature 68°F (20°C)
Isolation: Class 1	Drip Proof: IP23
Watts: 1600W (700W w/ heater off)	RPM: 11,000 - 20,000, Adjustable
Model, Voltage & Amps:	Mounting: Surface
HD0983 110/120 Volts 12.2-13.3 Amps	Dimensions: 12.67" W x 24.59" H x 7.28" D
HD0984 208/220 Volts 5.7-6.6 Amps	Weight: 23.80lbs
HD0985 (special order) 277 Volts 6.6 Amps	Colors: 08 Platinum, 16 Black, 17 White

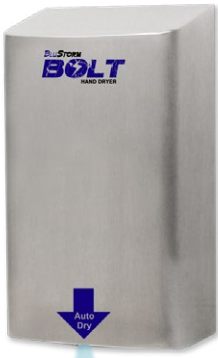

BluStorm Bolt High Speed Hand Dryer

Material: Stainless Steel	Motor Type: 11/16HP, Brush Type, Dual Ball Bearings
Operating Airflow: 21,243 LFM, Adjustable	Sound Level: 76.2 dB
Thermal Protection: Motor Shuts Off at 275°F (135°C) Heater Shuts Off at 185°F (85°C)	Air Output Temperature: 131°F (55°C) Ambient Temperature 77°F (25°C)
Isolation: Class 1	Drip Proof: IP23
Watts: 900W (450W w/ heater off)	RPM: 16,000 - 29,000, Adjustable
Model, Voltage & Amps:	Mounting: Surface
HD0923-09 110/120 Volts 4.17-8.33 Amps	Dimensions: 5.98" W x 10.56" H x 3.94" D
HD0924-09 208/220 Volts 1.91-3.82 Amps	Weight: 8.40lbs



High Grade Fire-Retardant ABS Hand Dryer

Material: ABS Plastic	Motor Type: 1/8 HP, Brushless, 100W
Operating Airflow: 3,242 LFM	Sound Level: 55±3dB
Thermal Protection: Heater Shuts Off at 286°F (141°C)	Air Output Temperature: 136°F (58°C) Ambient Temperature 68°F (20°C)
Isolation: Class 1	Drip Proof: IPX1
Watts: 1800W	RPM: 2,850
Model, Voltage & Amps:	Mounting: Surface
HD0903-17 110/120 Volts 13.8-15 Amps	Dimensions: 10.50" W x 8.75" H x 6.75" D 8.40lbs

BluStorm High Speed Hand Dryer - Surface or Recess Mount

Material: Stainless Steel	Motor Type: Adjustable brush type, dual ball bearings
Operating Airflow: 32.4-58.9 CFM, Adjustable	Sound Level: 68.2dB
Thermal Protection: Motor Shuts Off at 275°F (120V), 221°F (240V) Heater Shuts Off at 185°F (85°C)	Air Output Temperature: 131°F (55°C) Ambient Temperature 77°F (25°C)
Isolation: Class 1	Drip Proof: IP31
Watts: Heater Element 450-700W, Adjustable	RPM: 12,000-18,000, Adjustable
Model, Voltage & Amps:	Mounting: Surface or Recessed
HD0950-09 110/120 Volts 12.5-13.4 Amps	Dimensions: 8.94" W x 11.125" H x 6.97" D 12.10lbs (surface) 9.84" W x 20.20" H x 7.06" D 20.70lbs (recessed)
HD0951-09 220/240 Volts 8-8.5 Amps	
HD0955-09 110/120 Volts 12.5-13.4 Amps	



EcoStorm High Speed Hand Dryer - Surface or Recess Mount

Material: Stainless Steel	Motor Type: 3/4HP, 500W brush type, dual ball bearings
Operating Airflow: 17,752 LFM, Adjustable	Sound Level: 63.5dB
Thermal Protection: Motor Shuts Off at 221°F (105°C) Heater Shuts Off at 282°F (139°C)	Air Output Temperature: 131°F (55°C) Ambient Temperature 77°F (25°C)
Isolation: Class 1	Drip Proof: IPX1
Watts: 1000W	RPM: 29,000, Adjustable
Model, Voltage & Amps:	Mounting: Surface or Recessed
HD0940-09 110/120 Volts 8.4-10.5 Amps	Dimensions: 9.84" W x 7.09" H x 5.45" D 8.40lbs (surface) 10.71" W x 15.51" H x 5.56" D 15.40lbs (recessed)
HD0940-17	
HD0940-17H 110/120 Volts 8.4-10.5 Amps	*H Model includes a HEPA Filter
HD0945-09 110/120 Volts 8.4-10.5 Amps	



MOUNTING HEIGHTS - BluStorm

from bottom of dryer to the finished floor

Men	50"
Women	47"
Children (4-7)	35"
Children (8-10)	39"
Children (11-13)	43"
Children (14-16)	47"
Accessible	40"

MOUNTING HEIGHTS - EcoStorm

from bottom of dryer to the finished floor

Men	40"
Women	38"
Children (4-7)	32"
Children (8-10)	34"
Children (11-13)	36"
Children (14-16)	38"
Accessible	34"



Caution Wet Floor Sign

model	CS0702
dimensions (in)	11.50w x 24h x 20.50d
weight (lb)	1.33

19



Sanitary Napkin Container

model	CS000250
dimensions (in)	8.00w x 11.25h x 4.50d
weight (lb)	3.16

09 17



Plastic Toilet Seat Cover Dispenser

model	TS0143
dimensions (in)	18.24w x 15h x 1.91d
weight (lb)	.70

16

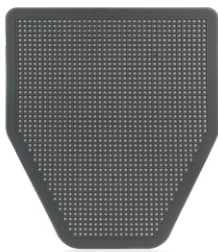

Disposable Urinal Mat

model	FM0148
dimensions (in)	17.75w x 20.50h x .03d
weight (lb)	.66

21



Disposable Commode Mat

model	FM0149
dimensions (in)	23w x 21.25h x .03d
weight (lb)	.83

21



Wall Mount Drip Tray

model	SP0503
dimensions (in)	4.50w x 6.75h x 4.00d
weight (lb)	.5

21



Brushed Chrome Toilet Seat Cover Dispenser

model	TS0142
dimensions (in)	16w x 11.75h x 2.50d
weight (lb)	2.16

11



Protective Plastic Face Shield

model	CS0509-23
dimensions (in)	9.00w x 10h x 10d
weight (lb)	less than .5 lb

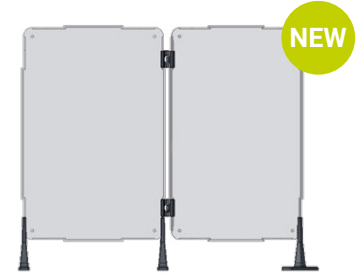

Sneeze Guard Panel Starter Kit

model	CS0507-23
dimensions (in)	16w x 24h x .375d
weight (lb)	2.80

Kit includes 2 panels, 3 legs, 2 clips, 2 hinges



18" and 24" Metal Grab Bars

model	CS0718
dimensions (in)	21.125w x 3.125h x 3.125d
weight (lb)	1.50

model	CS0724
dimensions (in)	27.125w x 3.125h x 3.125d
weight (lb)	1.83

09



30" Metal Grab Bars

model	CS0730
dimensions (in)	33.125w x 3.125h x 3.125d
weight (lb)	2.00

09





Mens Restroom Sign

model	IS1001
dimensions (in)	6w x 8h x .25d
weight (lb)	.5

15



Womens Restroom Sign

model	IS1003
dimensions (in)	6w x 8h x .25d
weight (lb)	.5

15



Unisex Restroom Sign

model	IS1005
dimensions (in)	6w x 8h x .25d
weight (lb)	.5

15



Boys Accessible Restroom Sign

model	IS1007
dimensions (in)	6w x 8h x .25d
weight (lb)	.5

15



Girls Accessible Restroom Sign

model	IS1008
dimensions (in)	6w x 8h x .25d
weight (lb)	.5

15



No Smoking Sign

model	IS1010
dimensions (in)	6w x 8h x .25d
weight (lb)	.5

15





Mens Accessible Restroom Sign

model	IS1002
dimensions (in)	6w x 8h x .25d
weight (lb)	.5

15 16



Womens Accessible Restroom Sign

model	IS1004
dimensions (in)	6w x 8h x .25d
weight (lb)	.5

15 16



Unisex Accessible Restroom Sign

model	IS1006
dimensions (in)	6w x 8h x .25d
weight (lb)	.5

15 16



Exit Sign

model	IS1011
dimensions (in)	9w x 6h x .25d
weight (lb)	.5

15



Employees Must Wash Hands Notice Sign

model	IS8001
dimensions (in)	10w x 7h x .25d
weight (lb)	.5

15 16 18 22



**NAPKIN
DISPENSERS**



**Counter Top Full Fold Napkin
Dispenser**

model	ND0071
dimensions (in)	7.50w x 5.125h x 11.75d
weight (lb)	3.85
capacity	300 Full Fold Napkins

13



**Table Top Low Fold Napkin
Dispenser**

model	ND0045
dimensions (in)	4.00w x 5.50h x 4.75d
weight (lb)	1.40
capacity	180 Low Fold Napkins

13



Palmer Fixture Napkin Dispenser are constructed of heavy gauge brushed steel, and feature non-marking rubber feet to protect surfaces. All napkin dispensers are designed for single napkin dispensing to help prevent waste. Counter Top models are top loading, while Table Top models load from both sides.





Tabletop Display Stand

model	SF0301
dimensions (in)	7.00w x 18.75h x 6.25d
weight (lb)	1.00

16



Metal Floor Display Stand

model	SF0320
dimensions (in)	6.00w x 48.00h x 14.00d
weight (lb)	15.00

16



Modular Plastic Display Stand

model	SF0503
dimensions (in)	17.50w x 15.13h x 17.50d
weight (lb)	6.20

16



Universal Metal Display Stand

model	SF0508
dimensions (in)	15.00w x 50.55h x 15.00d
weight (lb)	23.00

16

DISPENSER KEYS

For more information on Replacement Keys, visit www.palmerfixture.com or call **1-800-558-8678**. Please reference the individual product information tables to see which key fits a specific dispenser.

1 SP0100-00



2 SP0102-00



3 SP0103-00



4 SP0104-00



5 SP0105-00



6 SP0106-00



7 SP0101-00



8 SP0108-00



9 SP0107-00



10 SP0110-00



11 SP0111-00



13 SP0113-00



14 SP0130-00



15 SP0131-00



16 SP0132-00



17 SP0134-00



REPLACEMENT DISPENSER PARTS

Replacement parts are available for most Palmer Fixture dispensers, please call **1-800-558-8678** for replacement part information.

For Questions, Customer Service, Product or Warranty Information, Please Call: 1-800-558-8678

WARRANTY INFORMATION

Palmer Fixture Company LLC. warranties for a period of twelve (12) months from the date of sale that dispensers manufactured by Palmer shall be free from defects in workmanship and material and shall conform to Palmer's specifications.

The warranties set forth in this paragraph shall be in effect only if:

- 1) Written notice of a dispenser failure is provided to Palmer within the warranty period.
- 2) The dispenser has not been altered, tampered with, or modified in any way.
- 3) The dispenser failure is not caused by damage in transit, negligence, abuse, abnormal usage, misuse, accidents, or improper maintenance.

The dispensers manufactured by Palmer Fixture do not guarantee that all types of paper products will work. As a result, it is the responsibility of the buyer to determine the dispenser's suitability for the paper products used.

Palmer's obligation under this warranty is limited to and shall be fully discharged by repairing or replacing, F.O.B. Green Bay, WI, the dispenser or any part of the dispenser which is determined by Palmer not to be in conformity with the above warranty. If requested by Palmer, the defective dispenser or parts thereof, are to be returned to Palmer, transportation prepaid.

Palmer reserves the right to make changes in design and/or improvements in its products at any time without the obligation to make such changes or improvements in its products previously manufactured.

THE WARRANTIES FURNISHED BY PALMER HEREIN ARE IN LIEU OF ANY OTHER WARRANTIES OR GUARANTIES EXPRESSED OR IMPLIED, INCLUDING THE WARRANTIES OF MERCHANTABILITY AND FITNESS FOR A PARTICULAR PURPOSE.

NOT WITHSTANDING ANYTHING PROVIDED IN THE ABOVE WARRANTY OR IN ANY OTHER AGREEMENT BETWEEN PALMER AND BUYER, PALMER SHALL NOT BE LIABLE FOR ANY CONSEQUENTIAL, PROPERTY OR SPECIAL DAMAGES INCLUDING, BUT NOT LIMITED TO, ANY LOSS OF USE OR DOWNTIME WHICH BUYER MAY EXPERIENCE.

Hand Dryer Warranties vary in length.



NEW LACROSSE BRUSH LINE! BY PALMER FIXTURE

We value quality at Palmer Fixture. The LaCrosse Brush line is our latest cleaning solution, and we're excited to introduce it! These durable, efficient brushes clean even the toughest jobs, keeping your facility clean.



FOOD SERVICE



OUTDOOR



INDUSTRIAL



Palmer Fixture & LaCrosse Brush
MANUFACTURED IN GREEN BAY, WI
800.558.8678 | info@palmerfixture.com
www.palmerfixture.com | www.lacrossebrush.com



